

- **Weeks 1–2: informal introduction**

- network = path



- **Week 3: graph theory**

- **Weeks 4–7: models of computing**

- what can be computed (efficiently)?

- **Weeks 8–11: lower bounds**

- what cannot be computed (efficiently)?

- **Week 12: recap**

Week 4

- PN model: port numbering

Port-numbering model

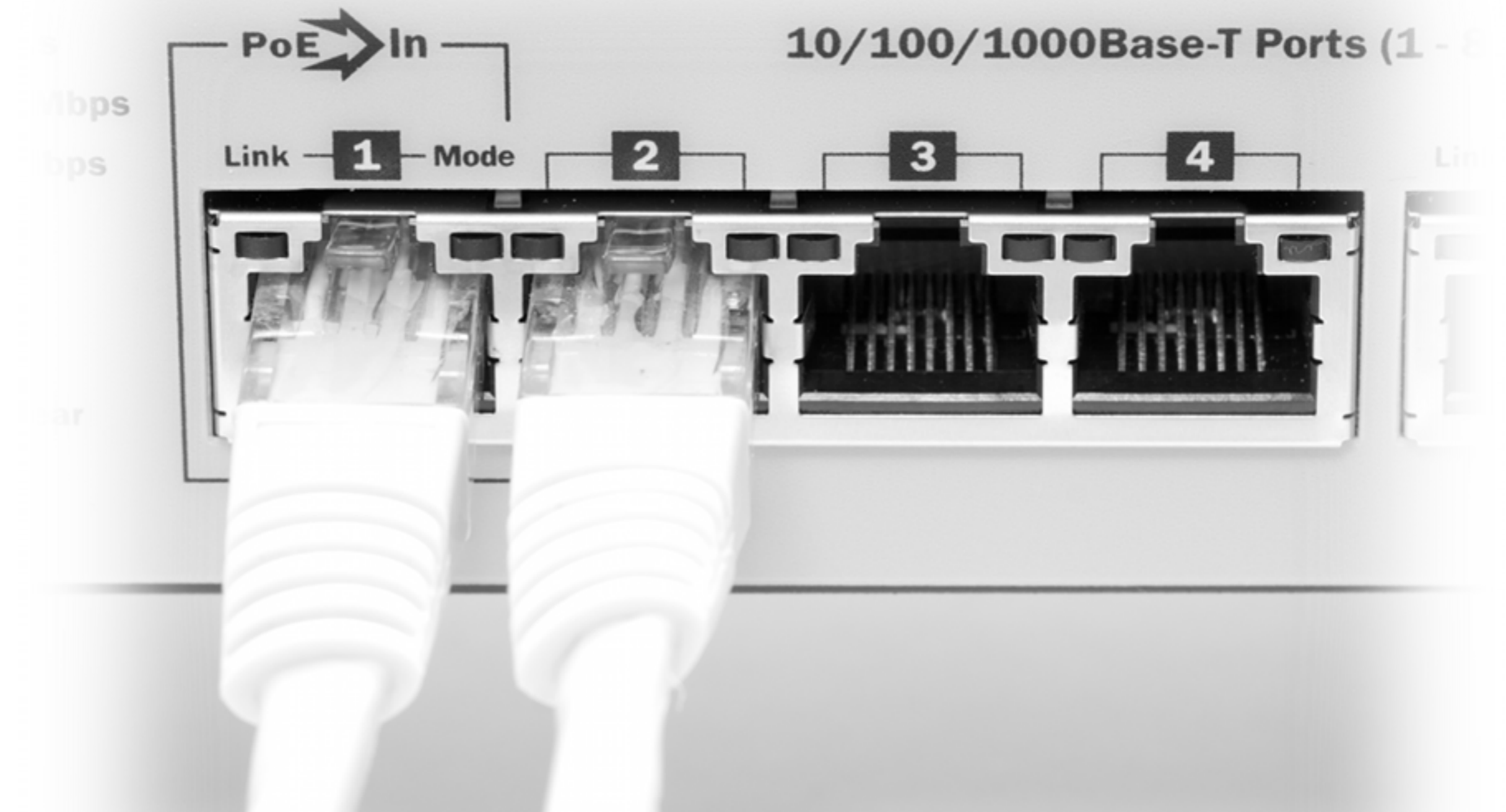

Port-numbering model

- **Simple and restrictive**
 - anonymous nodes, deterministic algorithms
- **All other models are extensions of PN model:**
 - Chapter 5: add unique identifiers
 - Chapter 6: add bandwidth restrictions
 - Chapter 7: add randomness

Port-numbered network

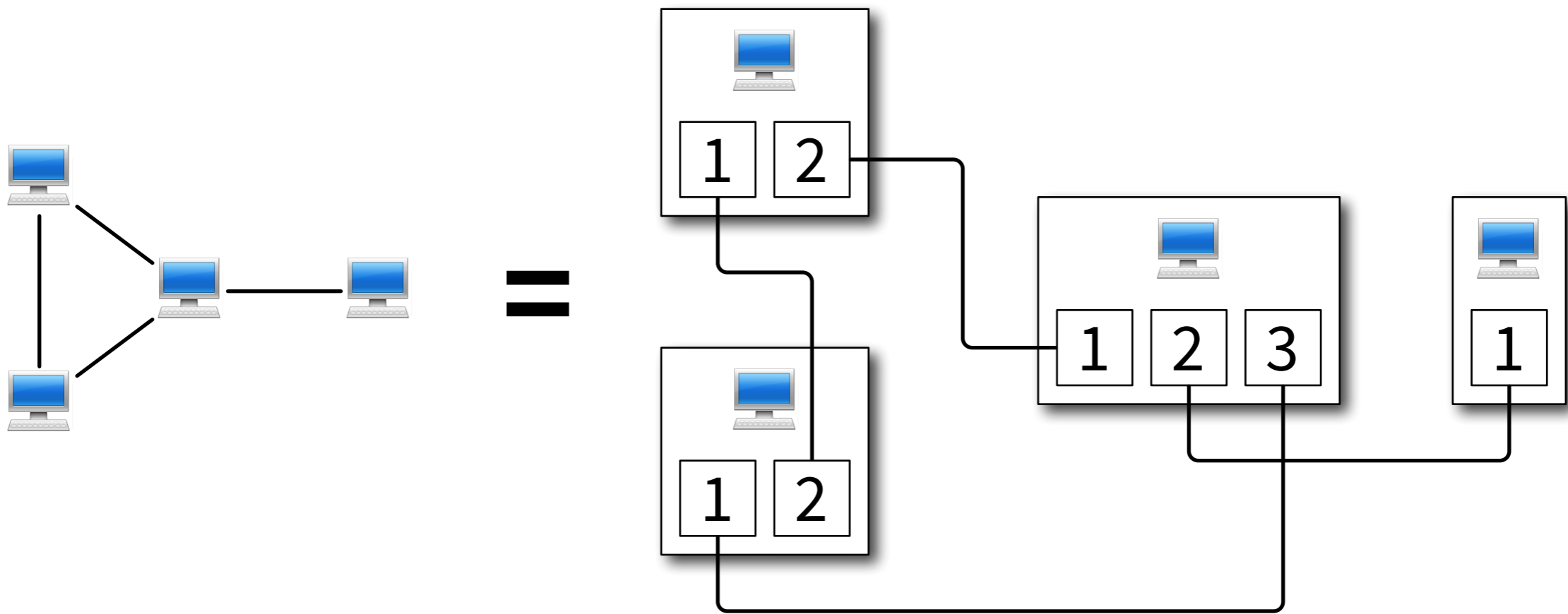

Port-numbered network

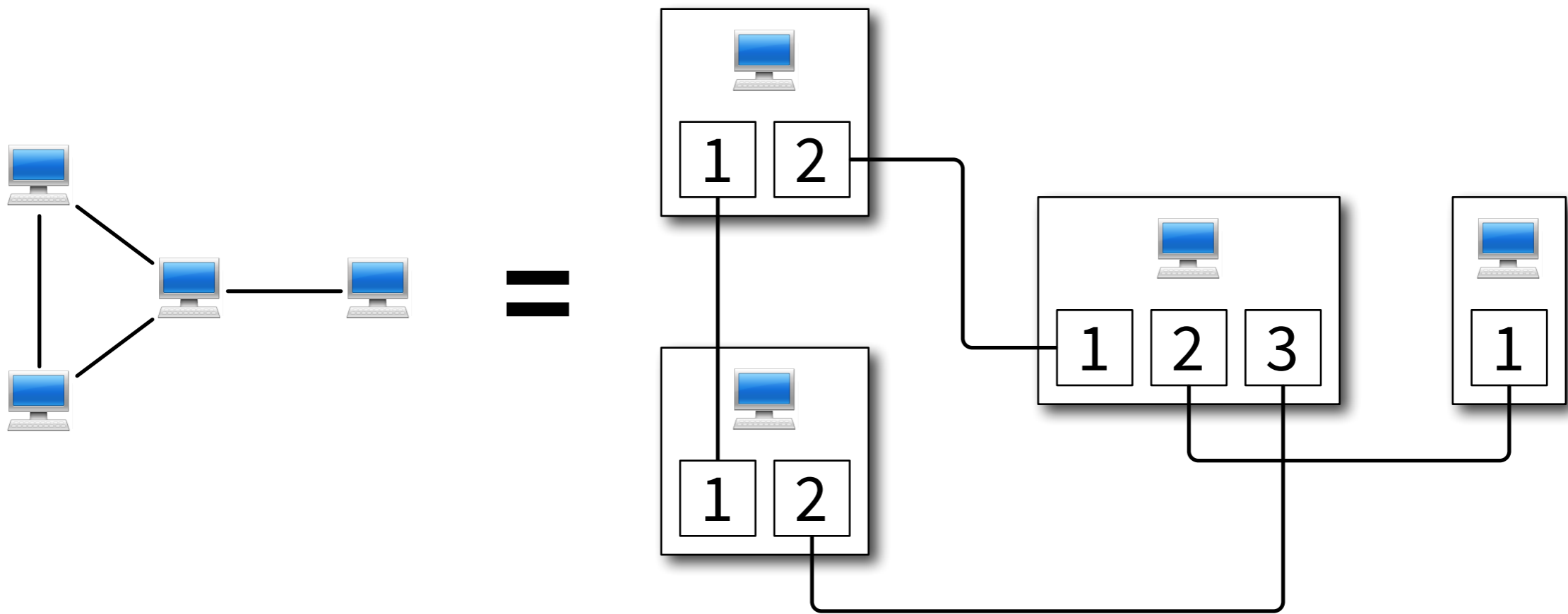

Underlying graph

$$G = (V, E)$$

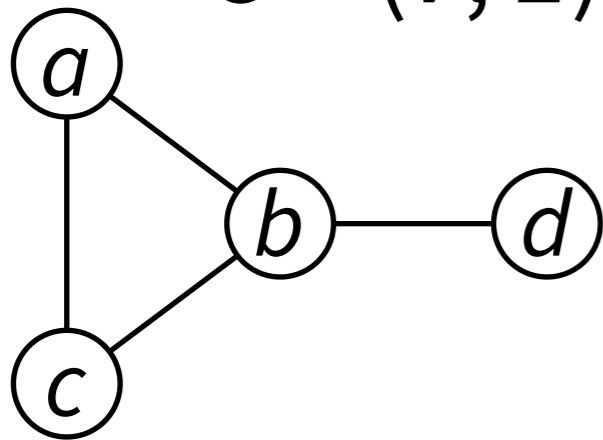

$$V = \{a, b, c, d\}$$

$$E = \{\{a,b\}, \{a,c\}, \{b,c\}, \{b,d\}\}$$

Port-numbered network

$$N = (V, P, p)$$

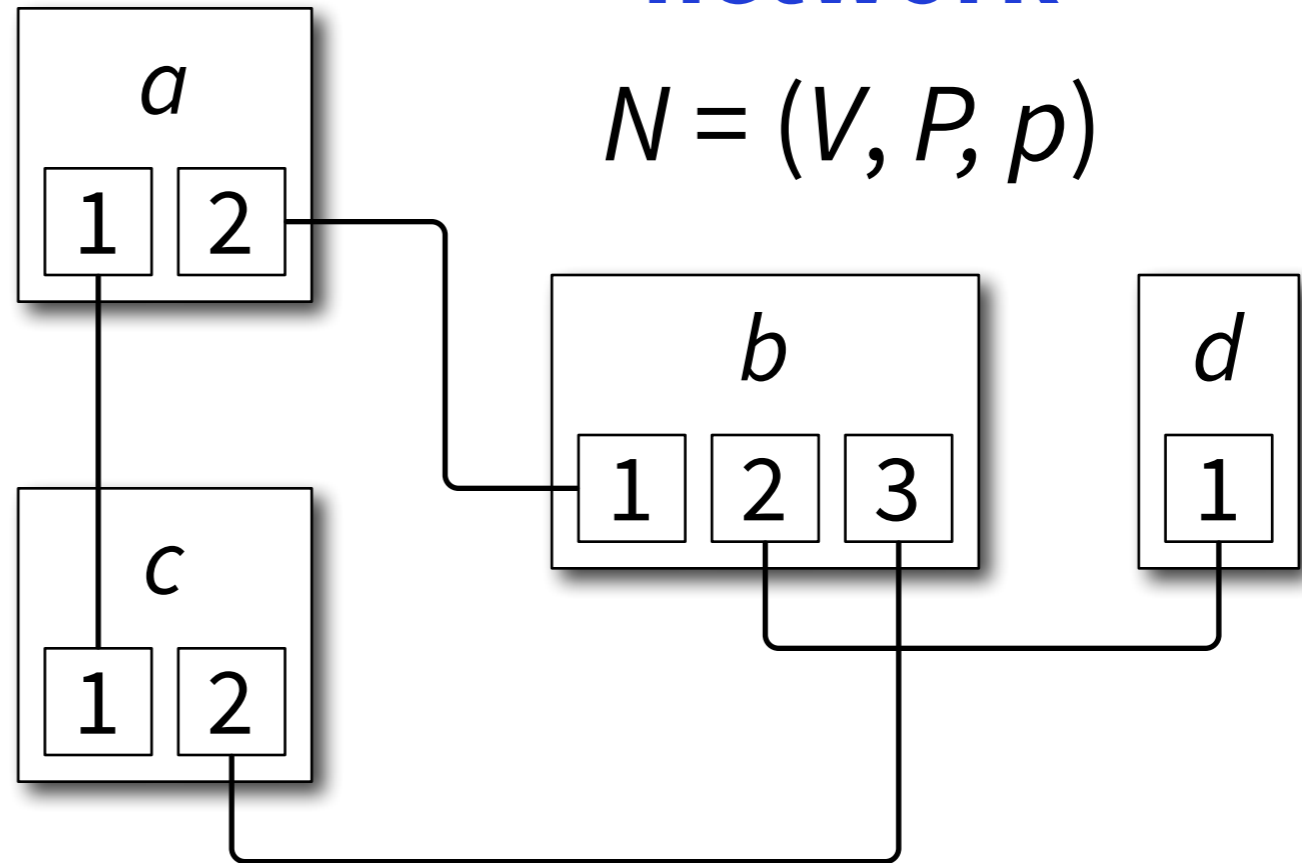

$$V = \{a, b, c, d\}$$

$$P = \{(a,1), (a,2), (b,1), (b,2), (b,3), (c,1), (c,2), (d,1)\}$$

$$p(a,1) = (c,1), p(a,2) = (b,1), \dots$$

Underlying graph

$$G = (V, E)$$

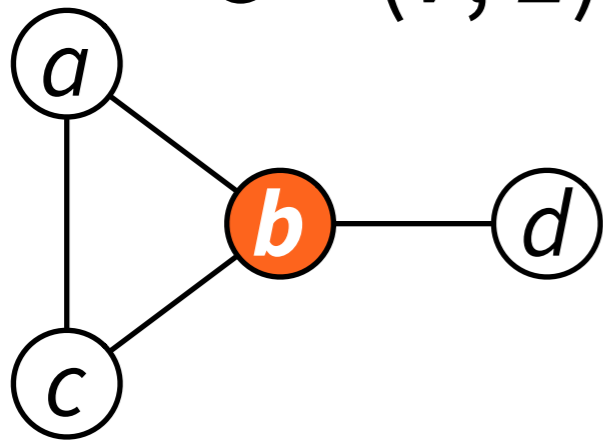

$$V = \{a, b, c, d\}$$

$$E = \{\{a,b\}, \{a,c\}, \{b,c\}, \{b,d\}\}$$

Port-numbered network

$$N = (V, P, p)$$

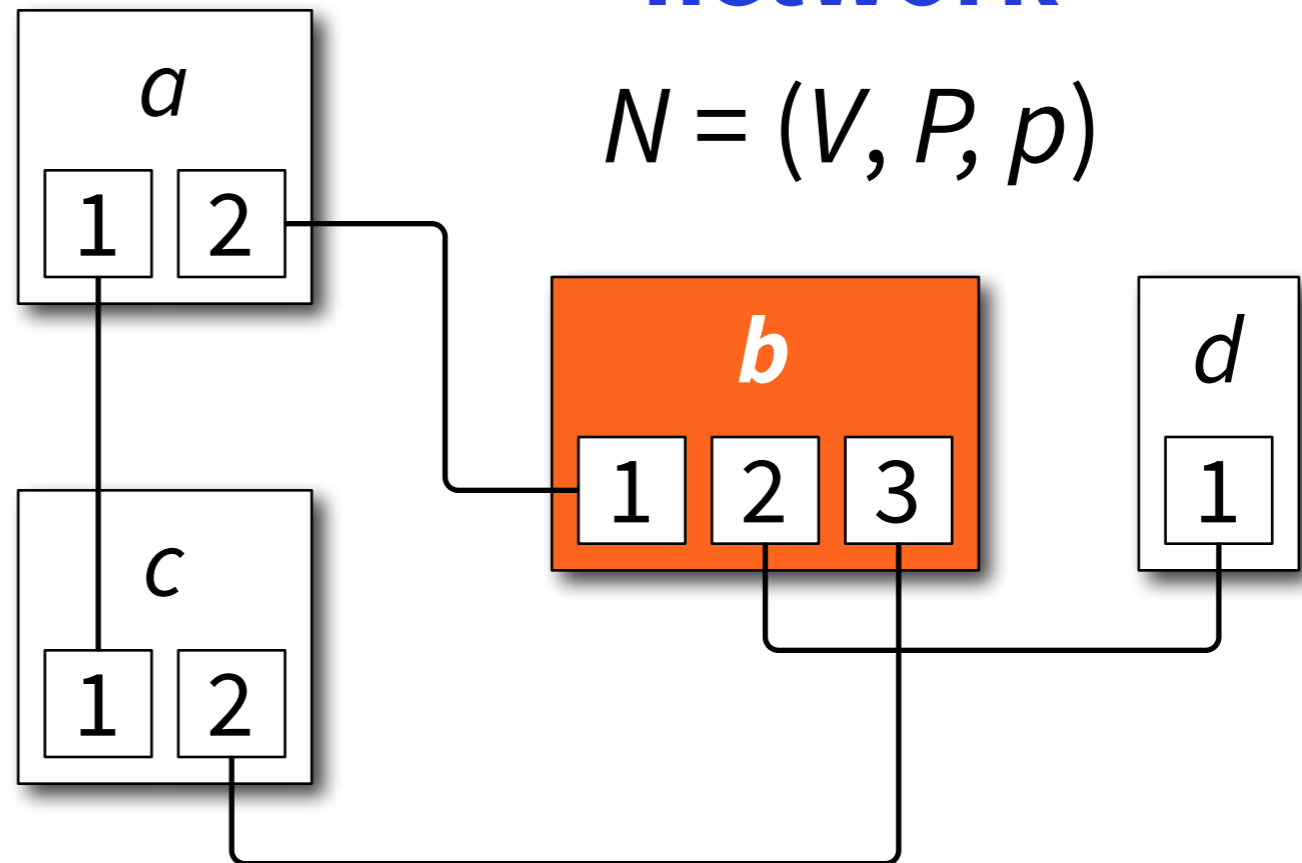

$$V = \{a, b, c, d\}$$

$$P = \{(a,1), (a,2), (b,1), (b,2), (b,3), (c,1), (c,2), (d,1)\}$$

$$p(a,1) = (c,1), p(a,2) = (b,1), \dots$$

Underlying graph

$$G = (V, E)$$

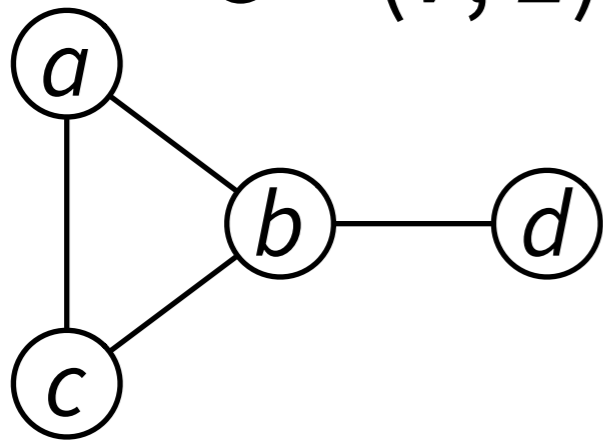

$$V = \{a, b, c, d\}$$

$$E = \{\{a,b\}, \{a,c\}, \{b,c\}, \{b,d\}\}$$

Port-numbered network

$$N = (V, P, p)$$

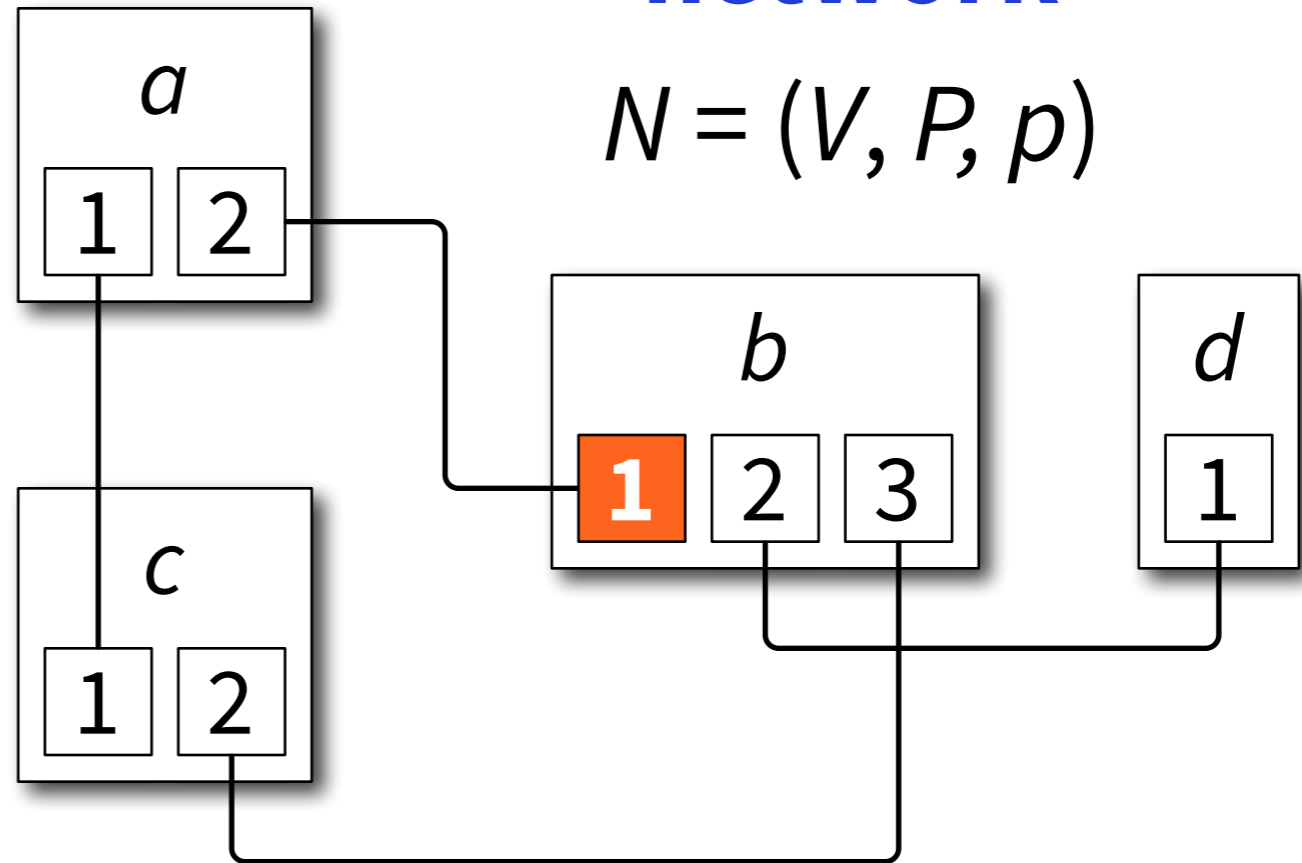

$$V = \{a, b, c, d\}$$

$$P = \{(a,1), (a,2), (b,1), (b,2), (b,3), (c,1), (c,2), (d,1)\}$$

$$p(a,1) = (c,1), p(a,2) = (b,1), \dots$$

Underlying graph

$$G = (V, E)$$

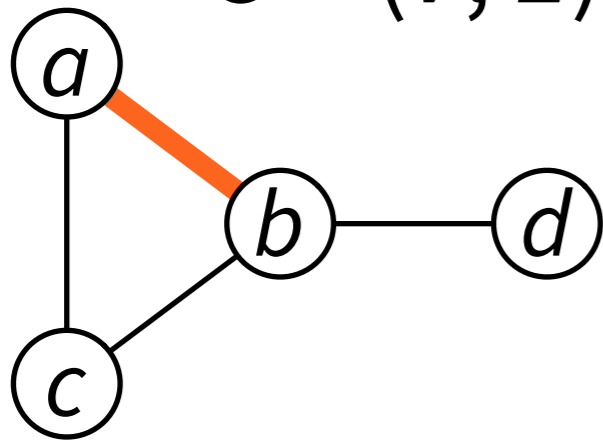

$$V = \{a, b, c, d\}$$

$$E = \{\{a,b\}, \{a,c\}, \{b,c\}, \{b,d\}\}$$

Port-numbered network

$$N = (V, P, p)$$

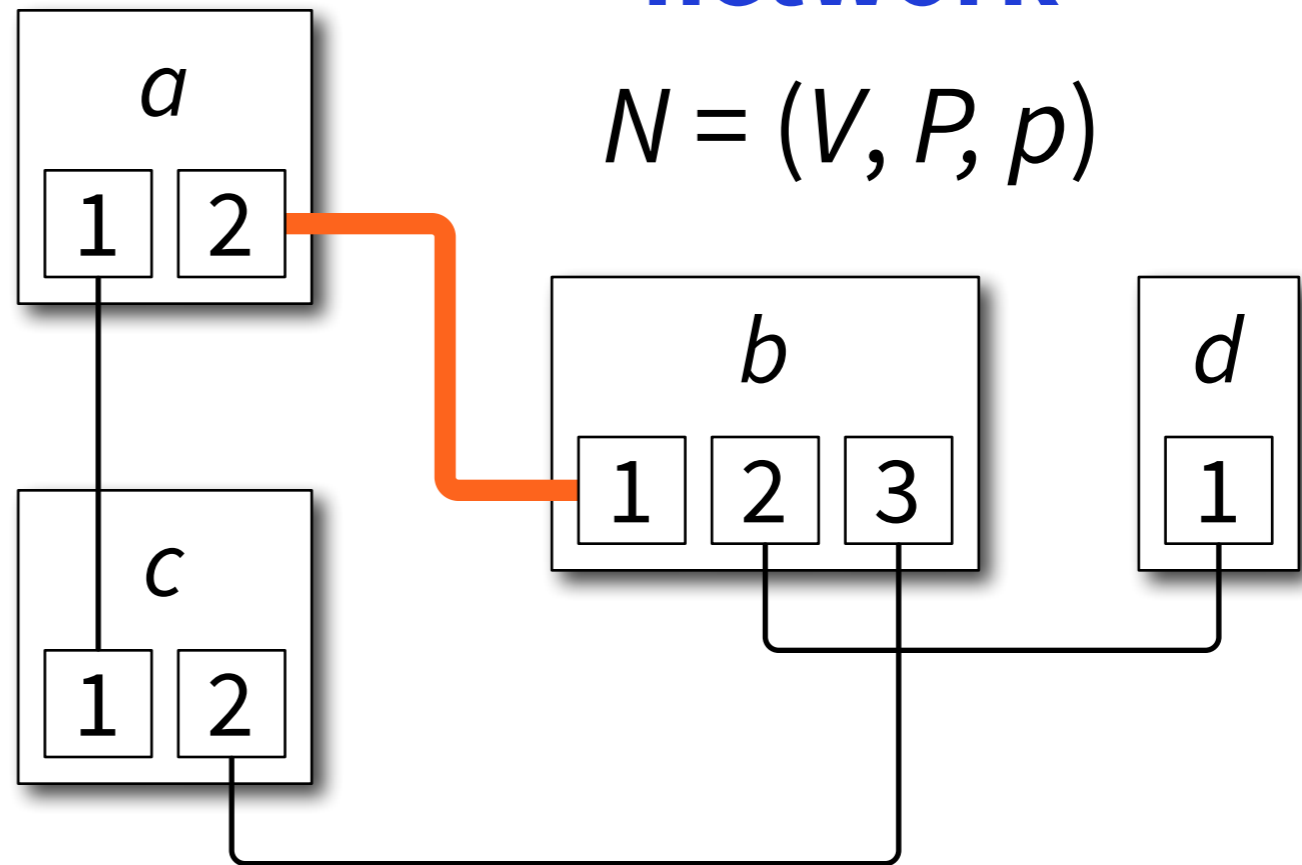

$$V = \{a, b, c, d\}$$

$$P = \{(a,1), (a,2), (b,1), (b,2), (b,3), (c,1), (c,2), (d,1)\}$$

$$p(a,1) = (c,1), \quad p(a,2) = (b,1), \quad \dots$$

Distributed algorithm in PN model

- **Algorithm = state machine**
- **Input, States, Output, Msg:** sets
- **$\text{init}_d, \text{send}_d, \text{receive}_d$:**
functions for each degree $d = 0, 1, 2, \dots$

Distributed algorithm in PN model

- **Input** = set of local inputs
- **States** = set of states
- **Output** = set of stopping states
- **Msg** = set of possible messages

Distributed algorithm in PN model

- **init_d: Input → States**

how to initialise the state machine

- **send_d: States → Msg^d**

how to construct outgoing messages

- **receive_d: States × Msg^d → States**

how to process incoming messages

Distributed algorithm in PN model

- $\text{init}_d(x) = y$

local state at time 0 if local input is x

- $\text{send}_d(x) = (m_1, m_2, \dots, m_d)$

what messages to send if local state is x

- $\text{receive}_d(x, m_1, m_2, \dots, m_d) = y$

new state after receiving these messages

Distributed algorithm in PN model

- **Execution** = sequence of state vectors

X_0, X_1, X_2, \dots

- $x_t(u)$ = state of node u at time t
- $x_0(u) = \text{init}_d(f(u))$
 - $f(u)$ is the local input of u
 - d = degree of u

Distributed algorithm in PN model

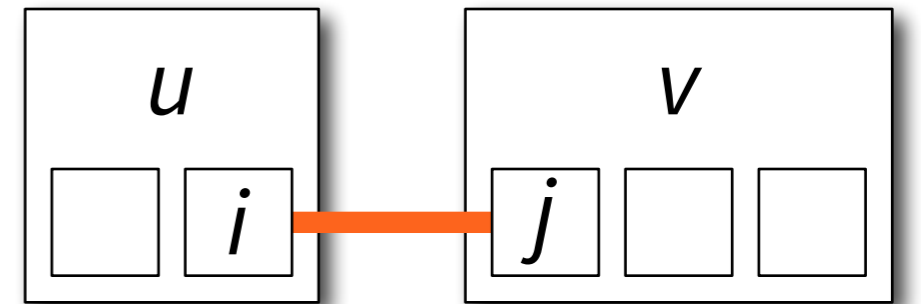

- Assume $p(u, i) = (v, j)$
- $m_t(u, i)$ = message received by u from port i
= message sent by v to port j
= component j of vector $\text{send}_d(x_{t-1}(v))$
- $x_t(u) = \text{receive}_d(x_{t-1}(u), m_t(u, 1), \dots, m_t(u, d))$

Distributed algorithm in PN model

- Current state + **send** → outgoing messages
- Outgoing messages + **p** → incoming messages
- Incoming messages + **receive** → new state

Distributed algorithm in PN model

- For any algorithm A and any network N :
execution x_0, x_1, x_2, \dots of A in N
- **Stops in time T if $x_T(v) \in \text{Output}$ for all v**
 - $x_T(v)$ is the local output of v

“ A solves problem X on graph family F ”

- Take **any graph G** from graph family F
- Take **any port-numbered network N** such that G is the underlying graph of N
- If we run A in N , then A stops and outputs a valid solution of problem X

“ A solves problem X on family F in time T ”

- Take **any graph G** from graph family F
- Take **any port-numbered network N** such that G is the underlying graph of N
- If we run A in N , then A stops **in time T** and outputs a valid solution of problem X

“ A solves X given Y on family F ”

- Take **any graph G** from graph family F
- Take **any port-numbered network N** such that G is the underlying graph of N
- If we run A in N with **any valid input f** then A stops and outputs a valid solution of problem X

Algorithm P3C: 3-colouring paths

- **Local maxima** pick a new colour from {1,2,3}

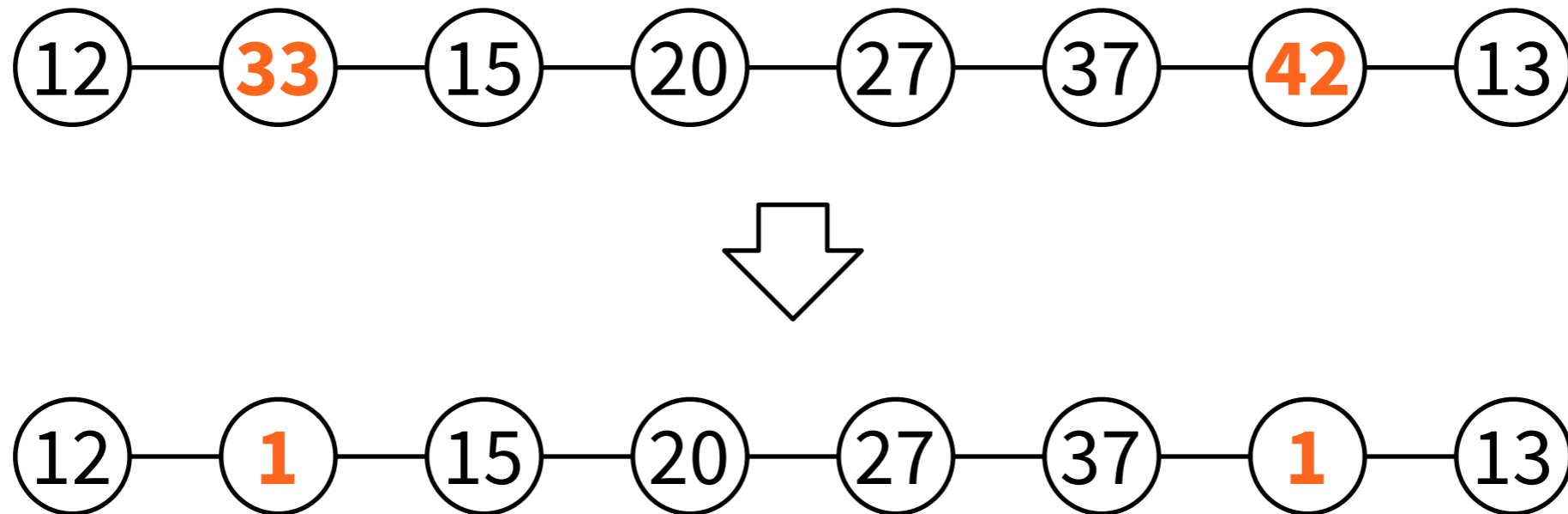

Algorithm P3C: **3-colouring paths**

- “**Algorithm P3C solves problem X given Y on graph family F in time $O(|V|)$ ”**
- **$X = 3\text{-colouring}$**
- **$Y = \text{colouring}$** (with any number of colours)
- **$F = \text{path graphs}$**

Algorithm P3C: **3-colouring paths**

- **Input = {1, 2, ...}**
- **States = {1, 2, ...}**
- **Output = {1, 2, 3}**
- **Msg = {1, 2, ...}**

Algorithm P3C: **3-colouring paths**

- **$\text{init}_0(x) = x$**
- **$\text{init}_1(x) = x$**
- **$\text{init}_2(x) = x$**

Algorithm P3C:

3-colouring paths

- **$\text{send}_0(x) = ()$**
- **$\text{send}_1(x) = (x)$**
- **$\text{send}_2(x) = (x, x)$**

Algorithm P3C: **3-colouring paths**

- $\text{receive}_0(x) = \mathbf{1}$ if $x \notin \text{Output}$
- $\text{receive}_0(x) = x$ otherwise

Algorithm P3C: **3-colouring paths**

- **receive₁(x, y) = min({1, 2} \ {y})**
if $x \notin \text{Output}$ and $x > y$
- **receive₁(x, y) = x** otherwise

Algorithm P3C: **3-colouring paths**

- **receive₂(x, y, z) = min({1, 2, 3} \ {y, z})**
if $x \notin \text{Output}$ and $x > y$ and $x > z$
- **receive₂(x, y, z) = x** otherwise

Key question

- **What can be solved in PN model**
without any additional input?
 - no colouring, unique identifiers, etc.
 - no randomness
- **Example: 3-approximation**
of minimum vertex cover

Algorithm VC3:

Small vertex covers

- **Original graph G : without any colouring**
- **Virtual graph G' : 2-coloured**
- **Find a maximal matching M' in G'**
- **Use M' to find a 3-approximation of a minimum vertex cover in G**

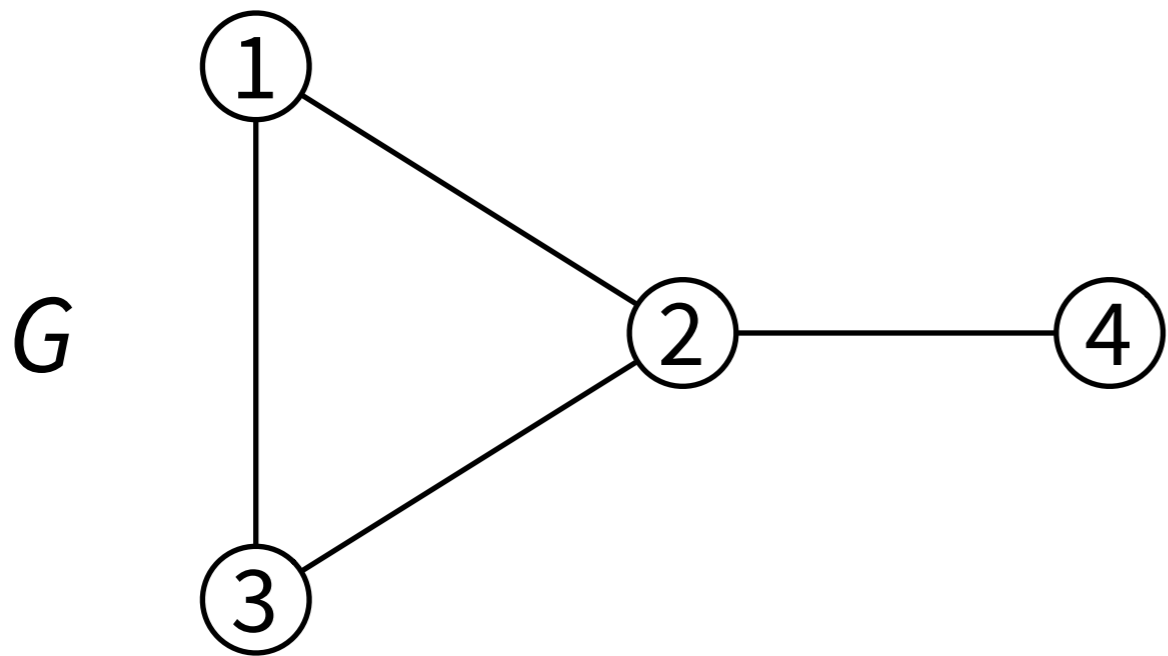

**Construct
virtual
graph G'**

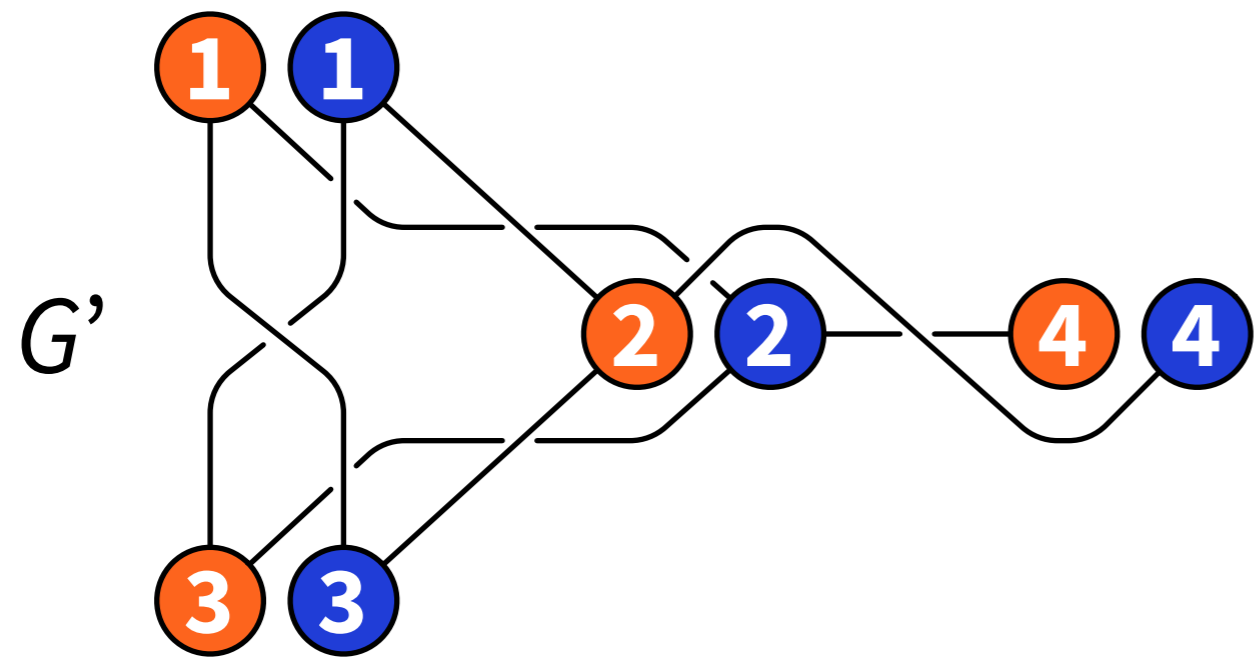

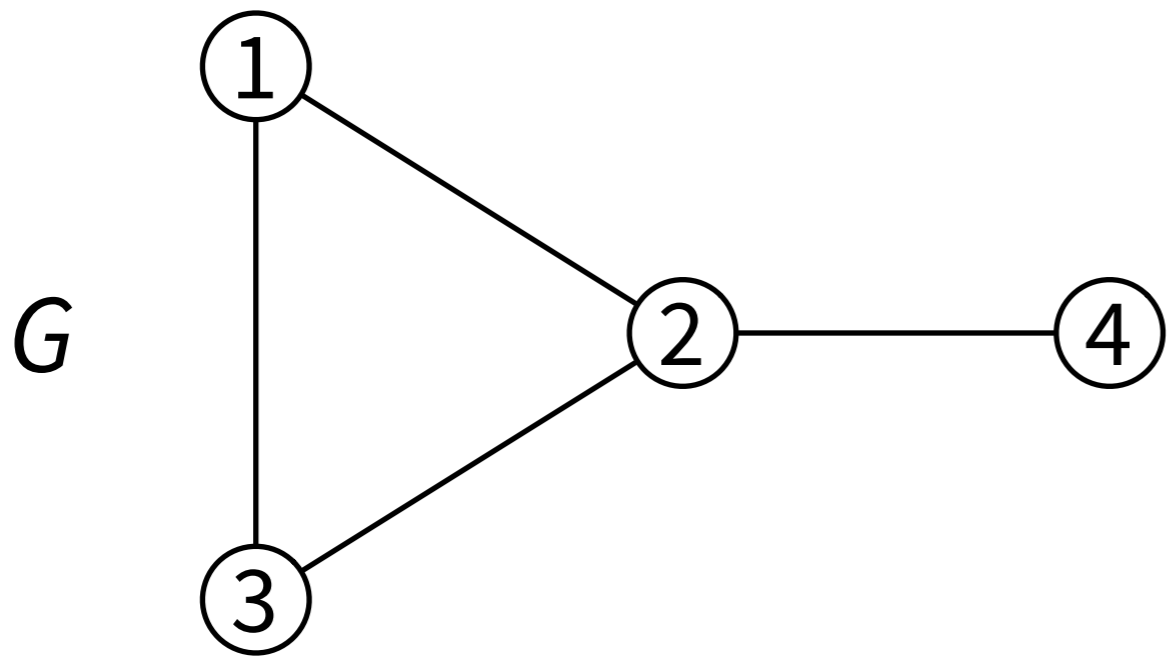

**Construct
virtual
graph G'**

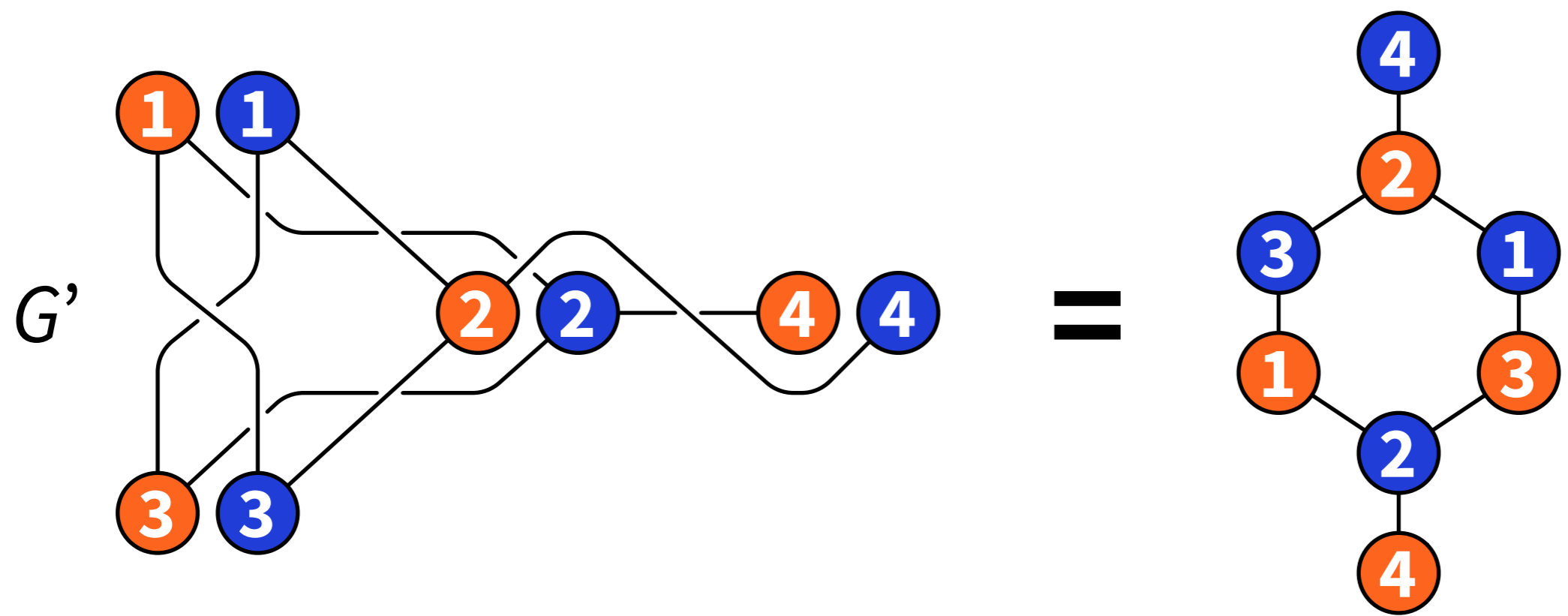

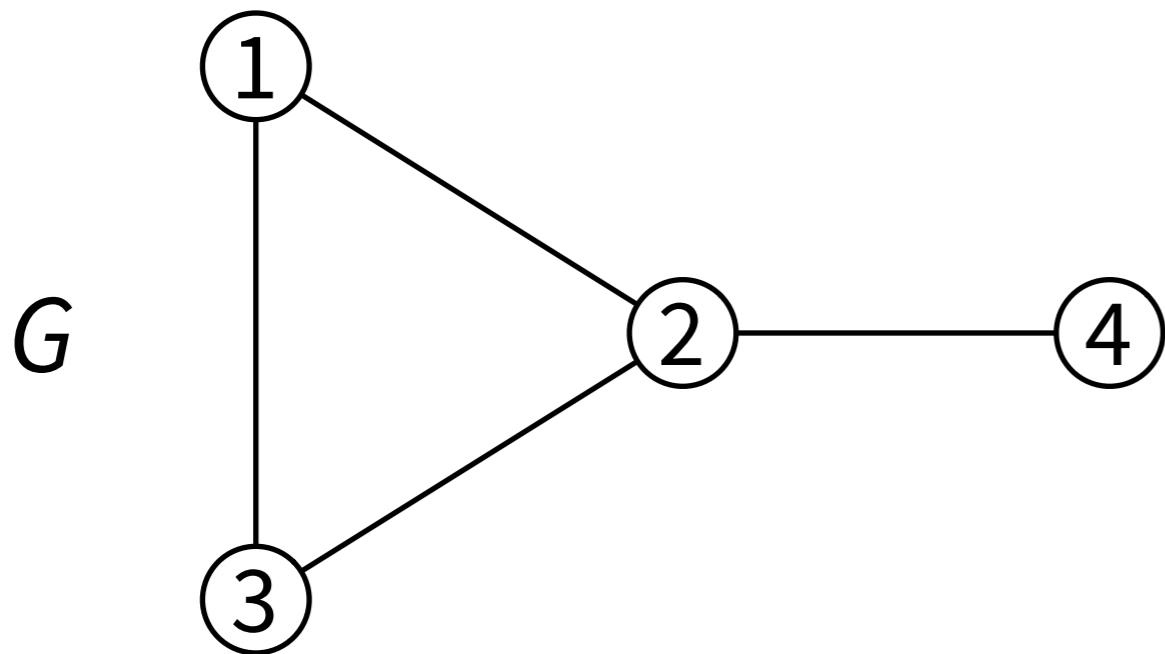

Find maximal matching M' in graph G'

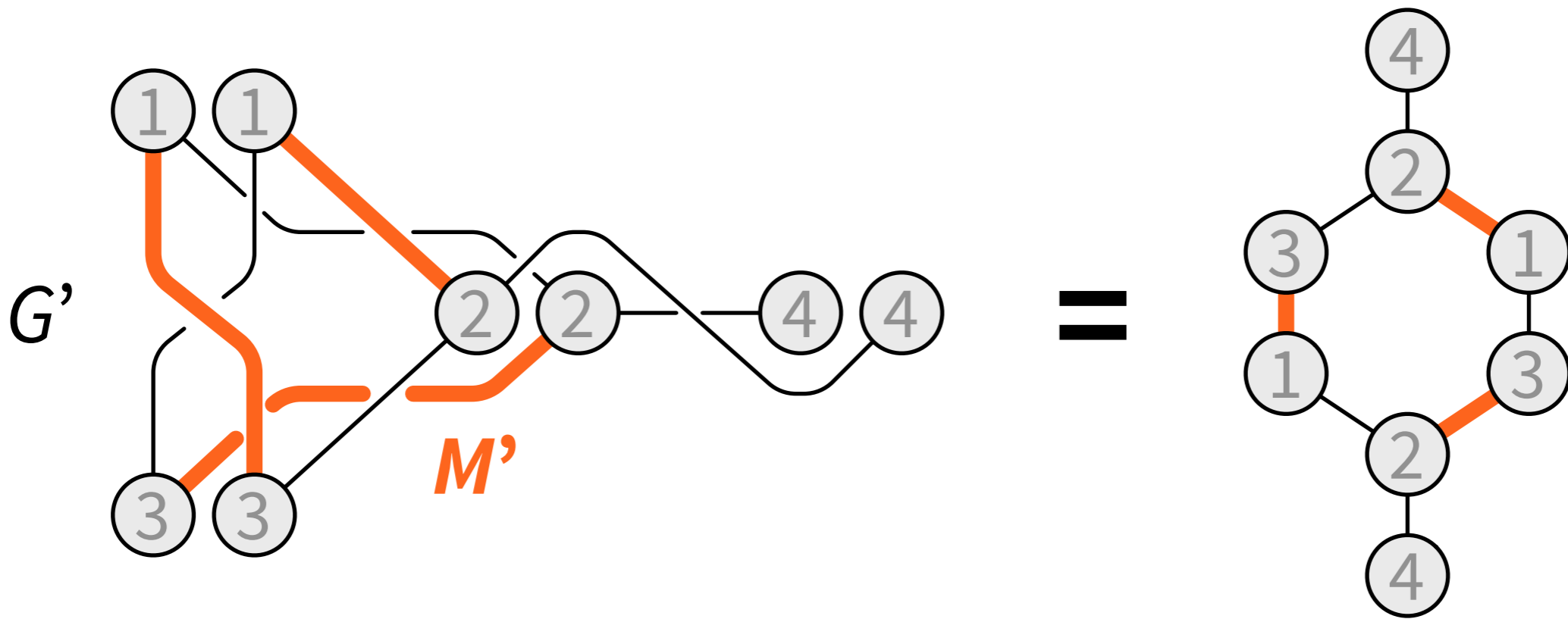

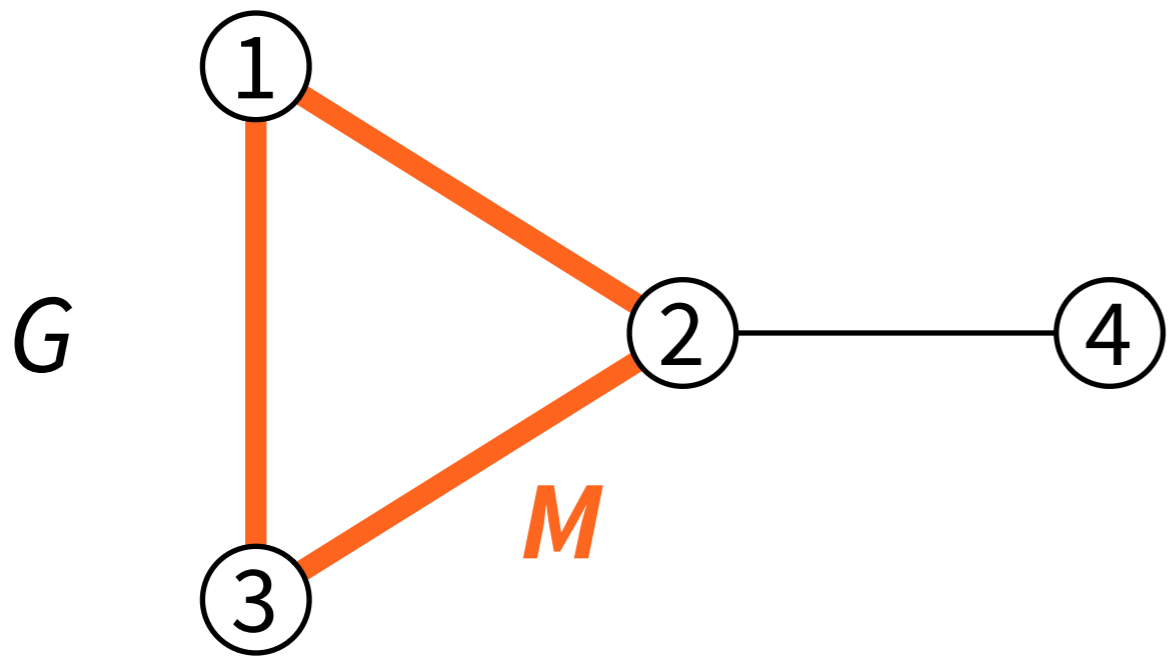

Map back to original graph

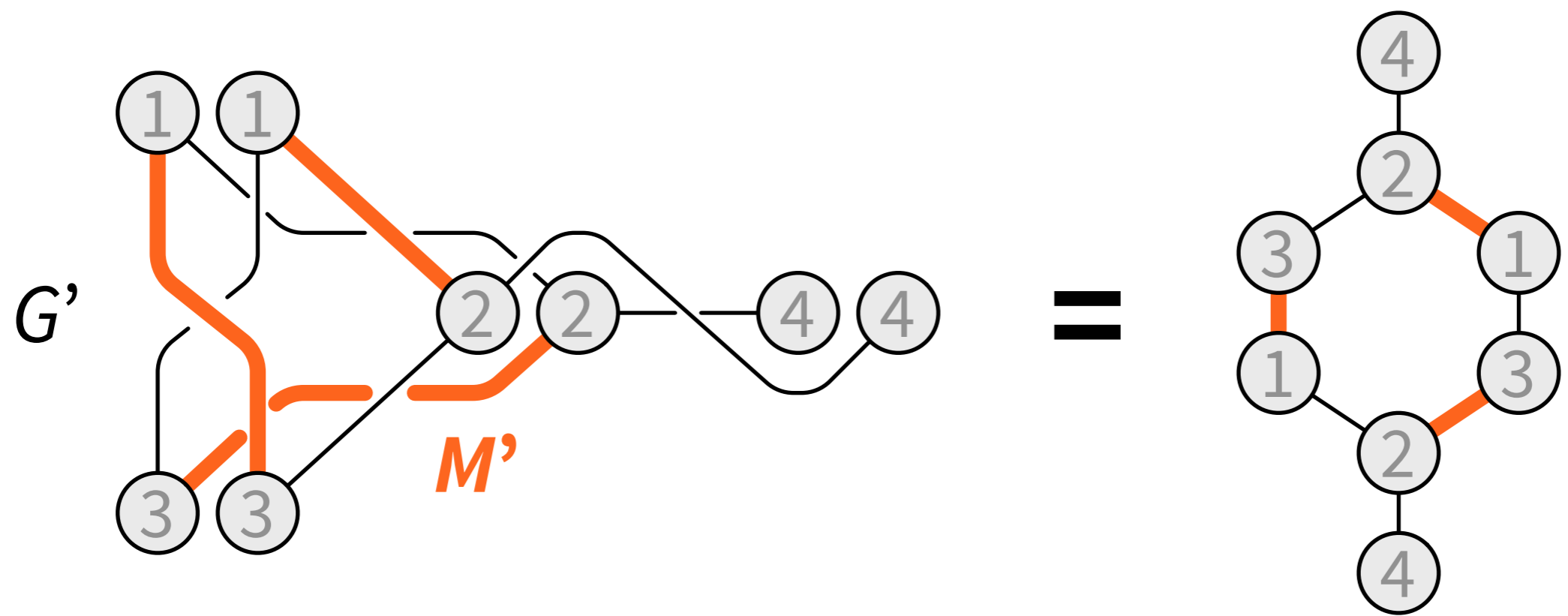

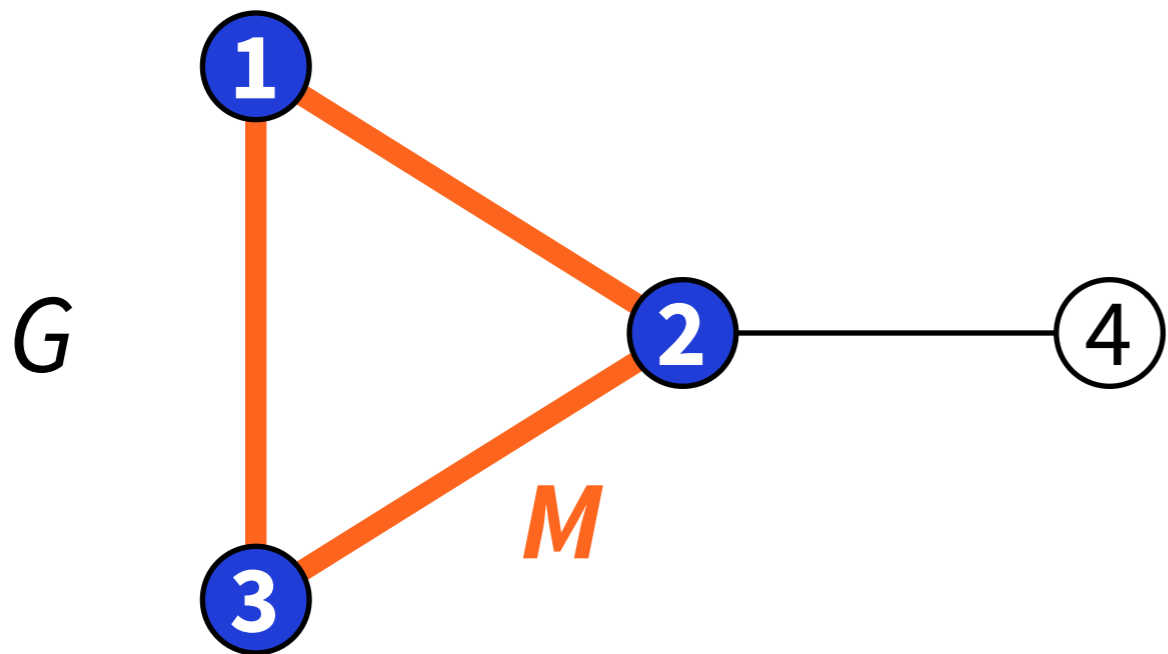

**Vertex cover =
all nodes
incident to M**

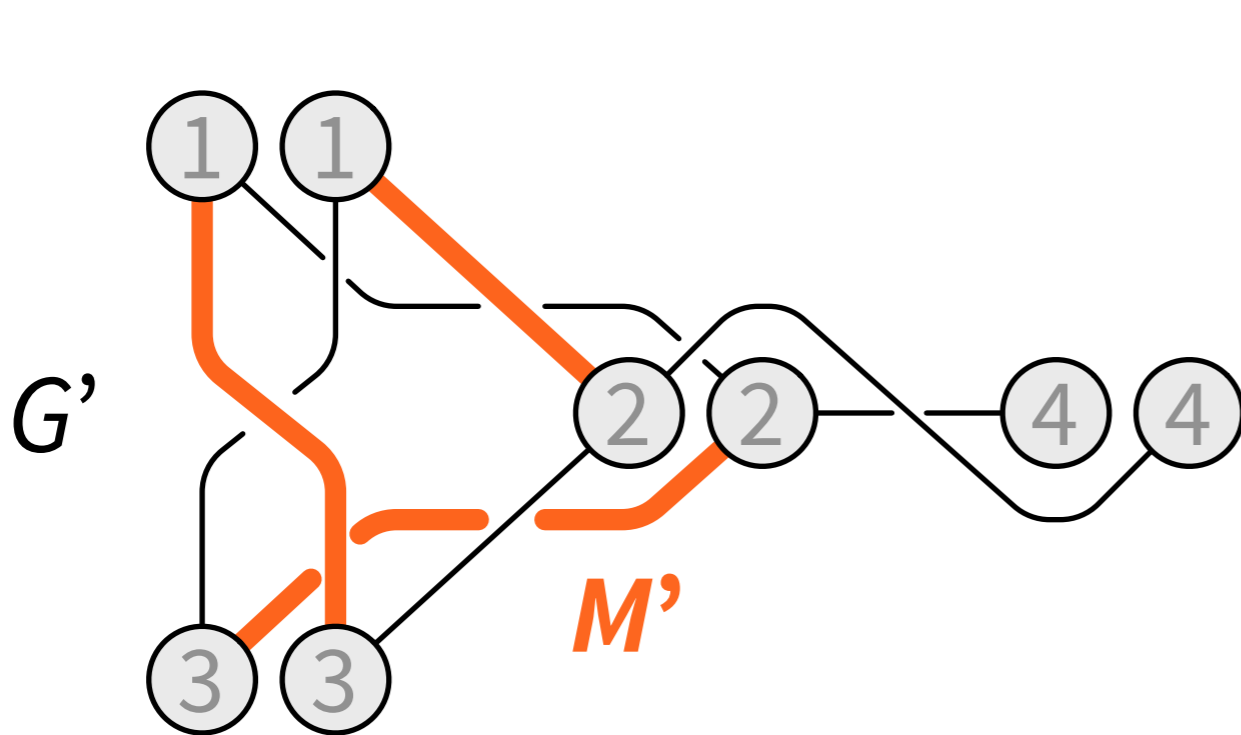

=

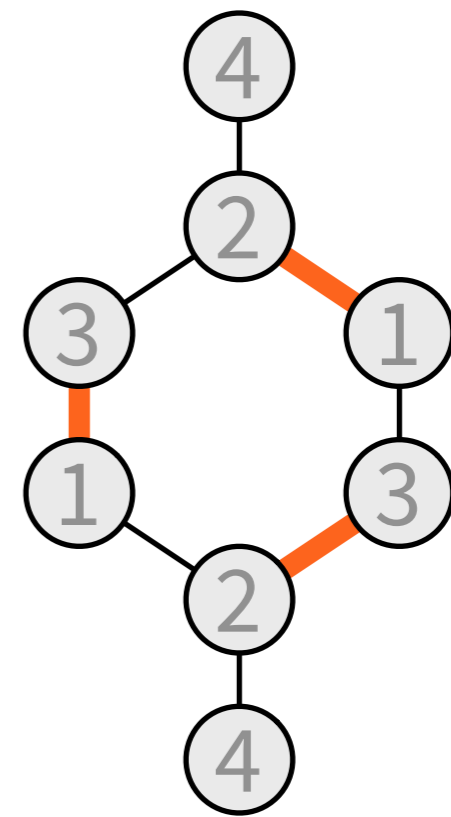

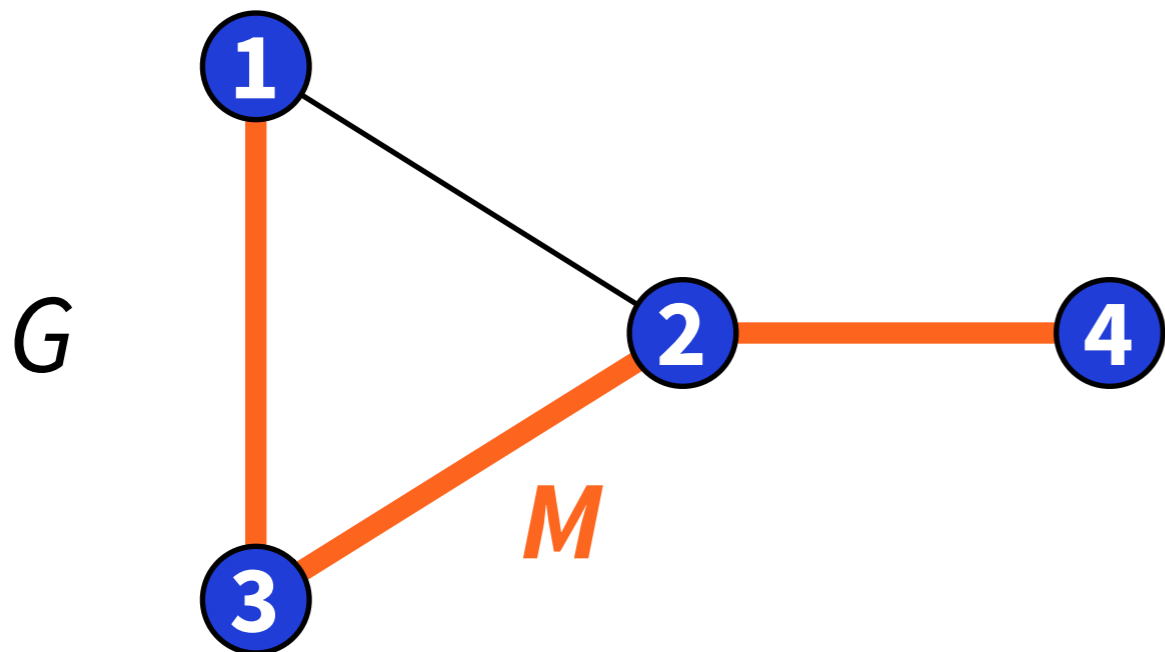

**Vertex cover =
all nodes
incident to M**

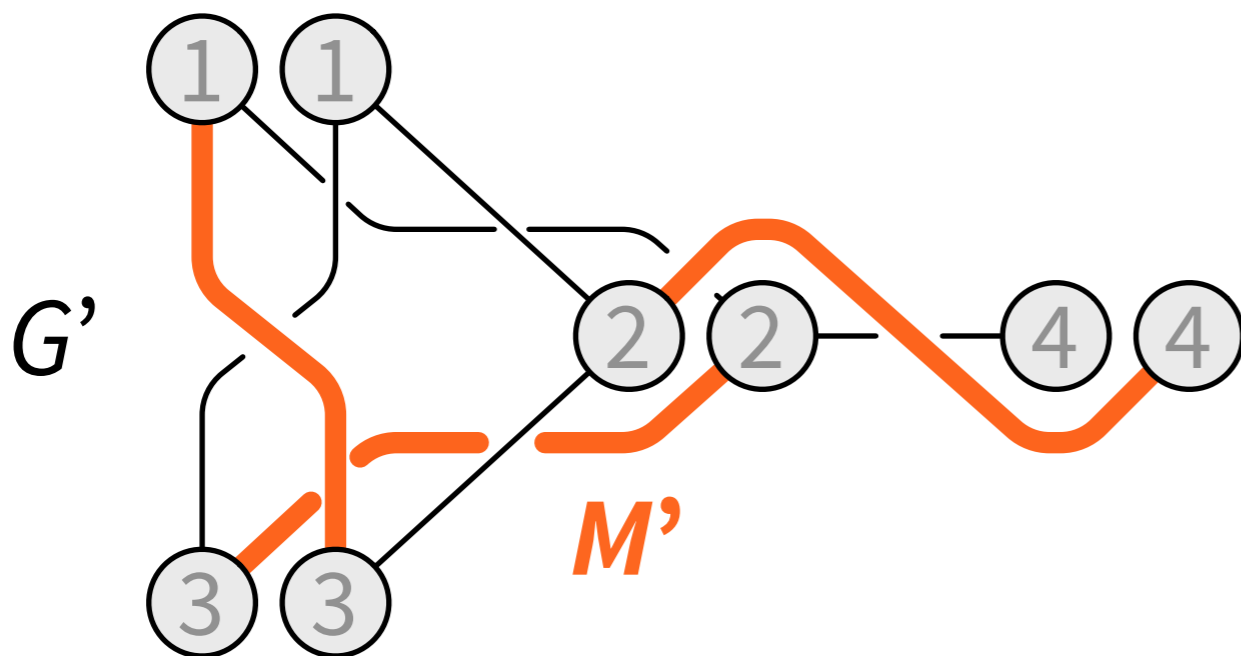

=

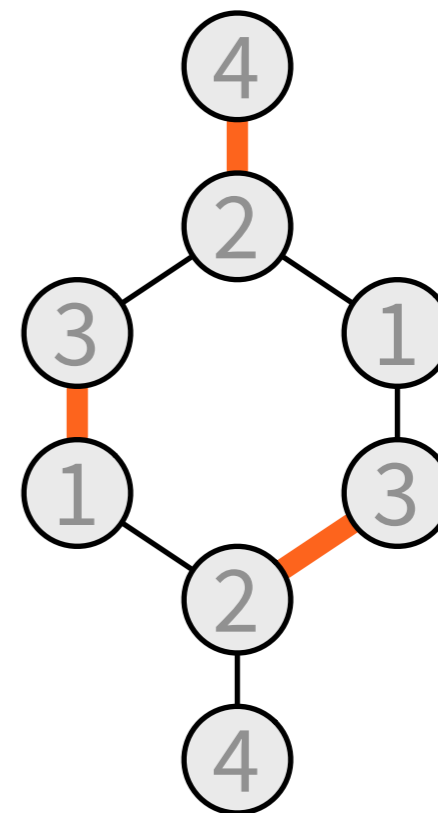

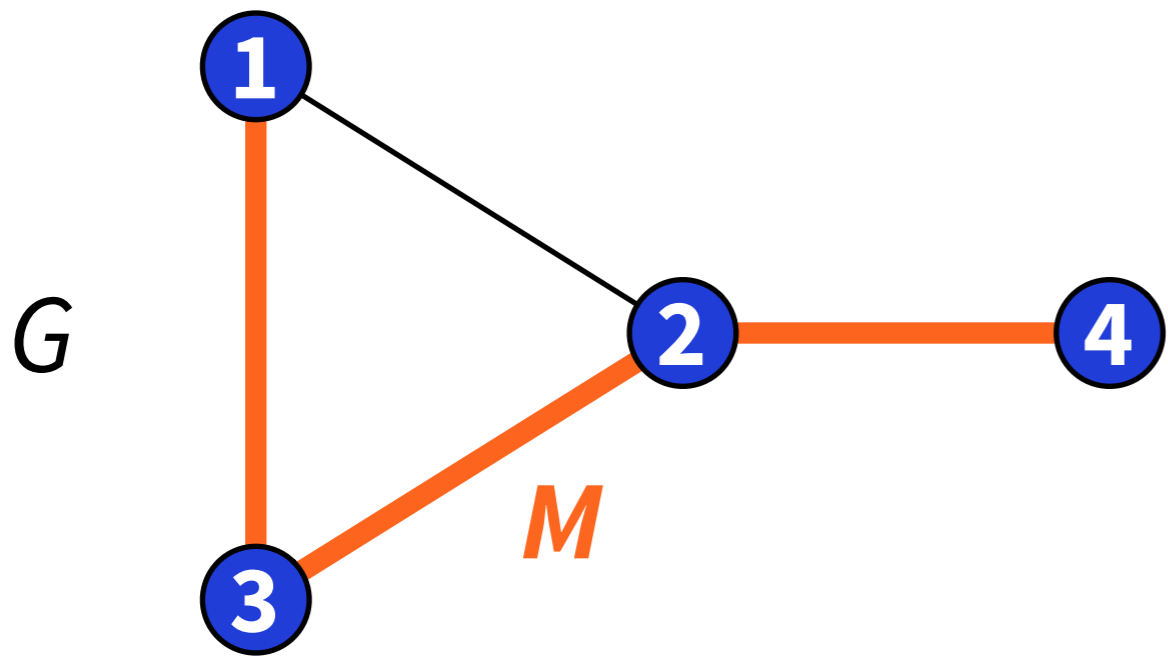

**Why
vertex
cover?**

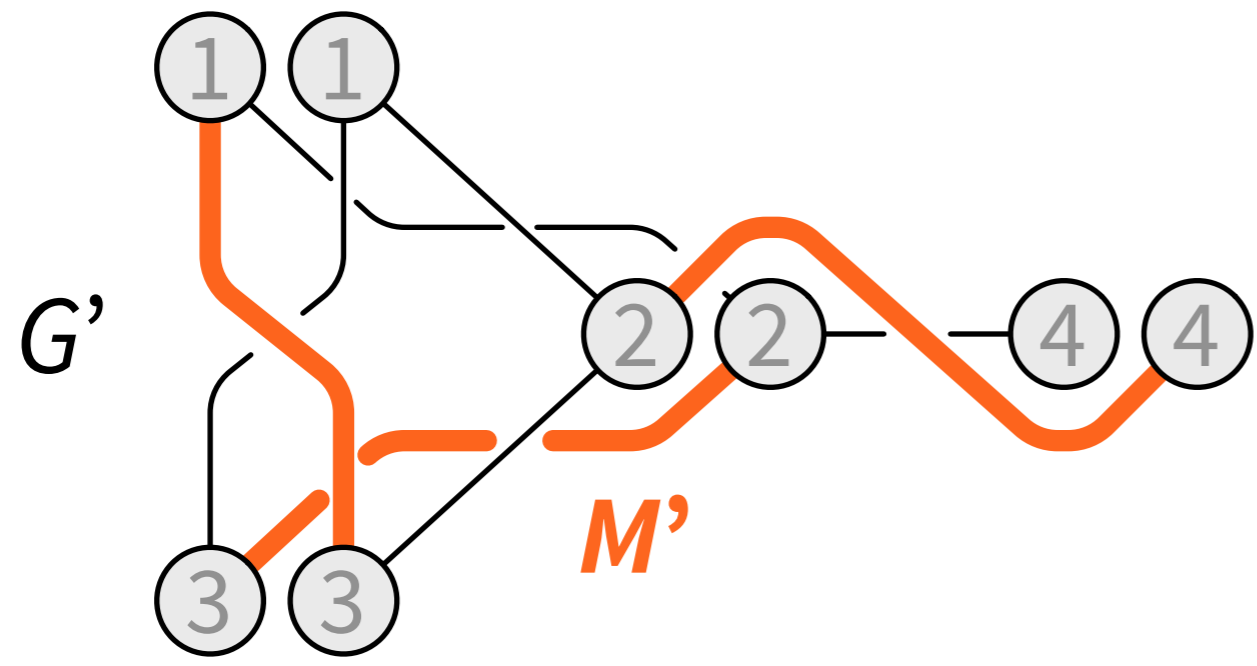

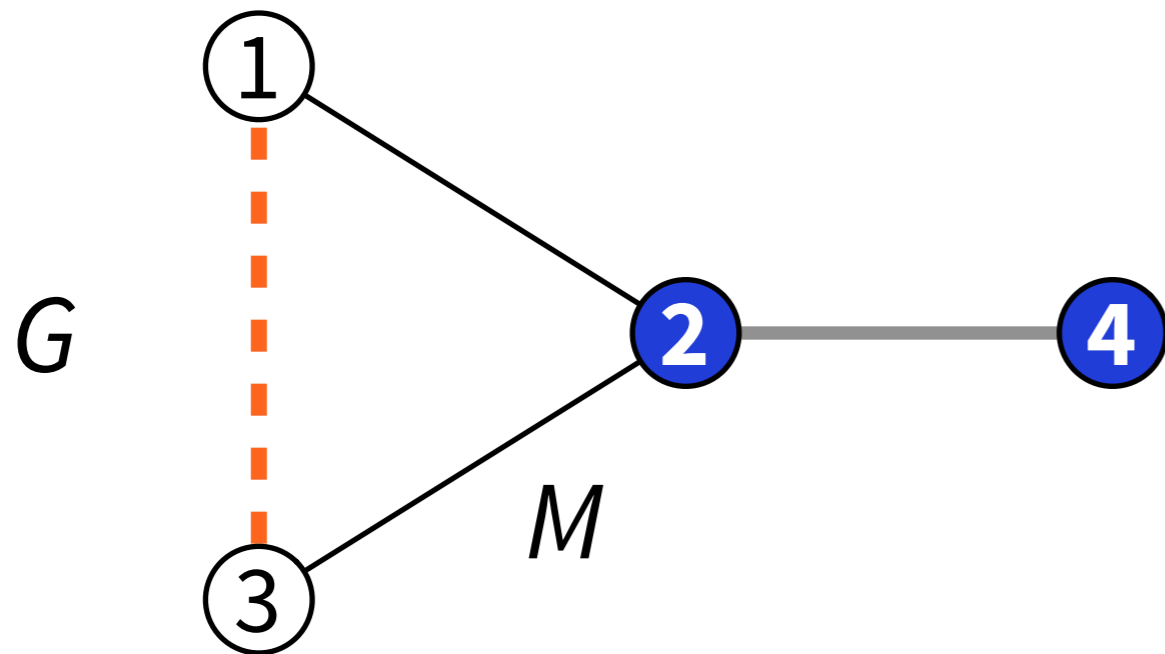

Edge not covered
→ M' not maximal

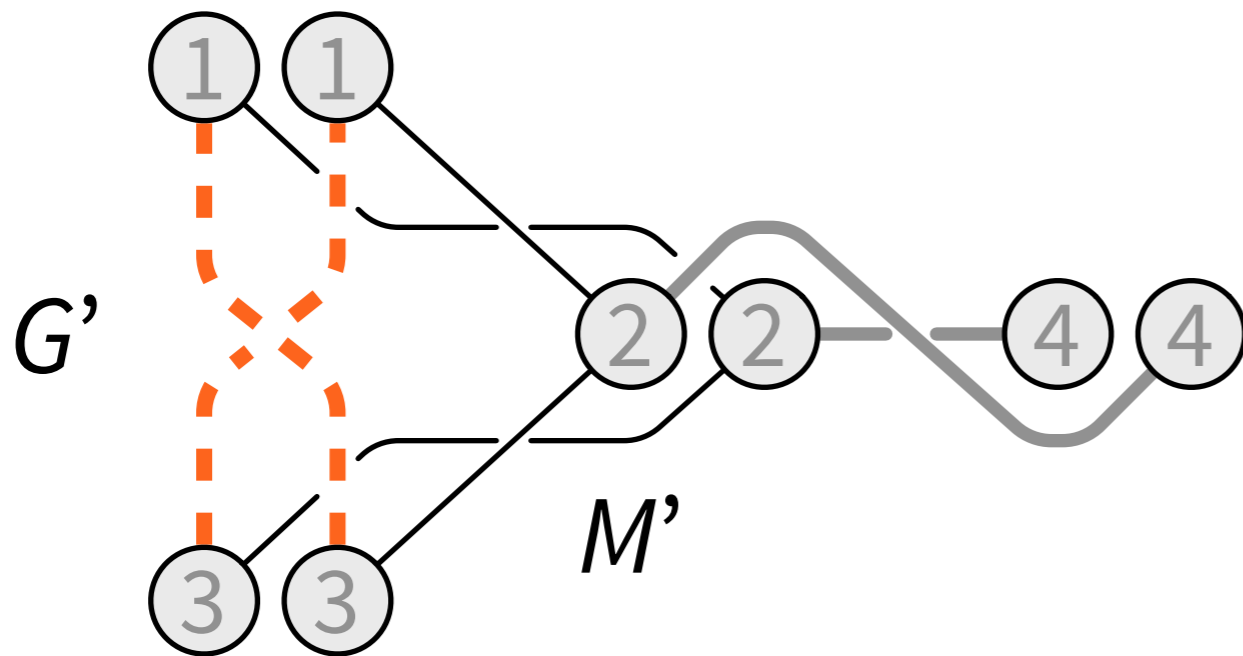

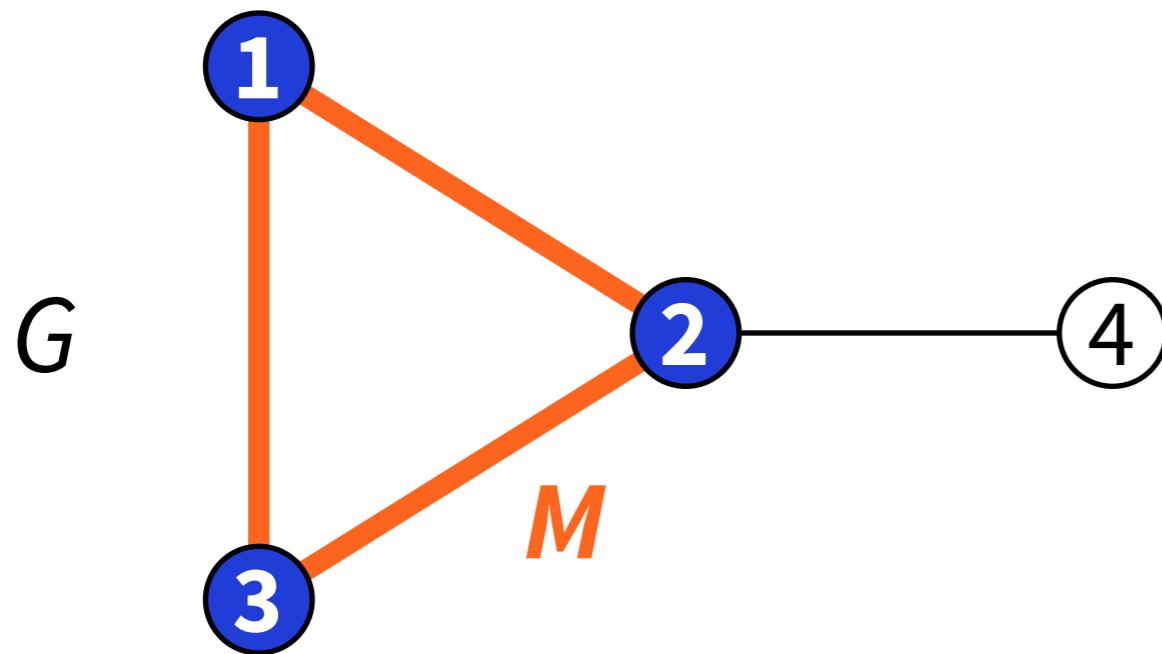

**Why within
factor 3 of
minimum
vertex cover?**

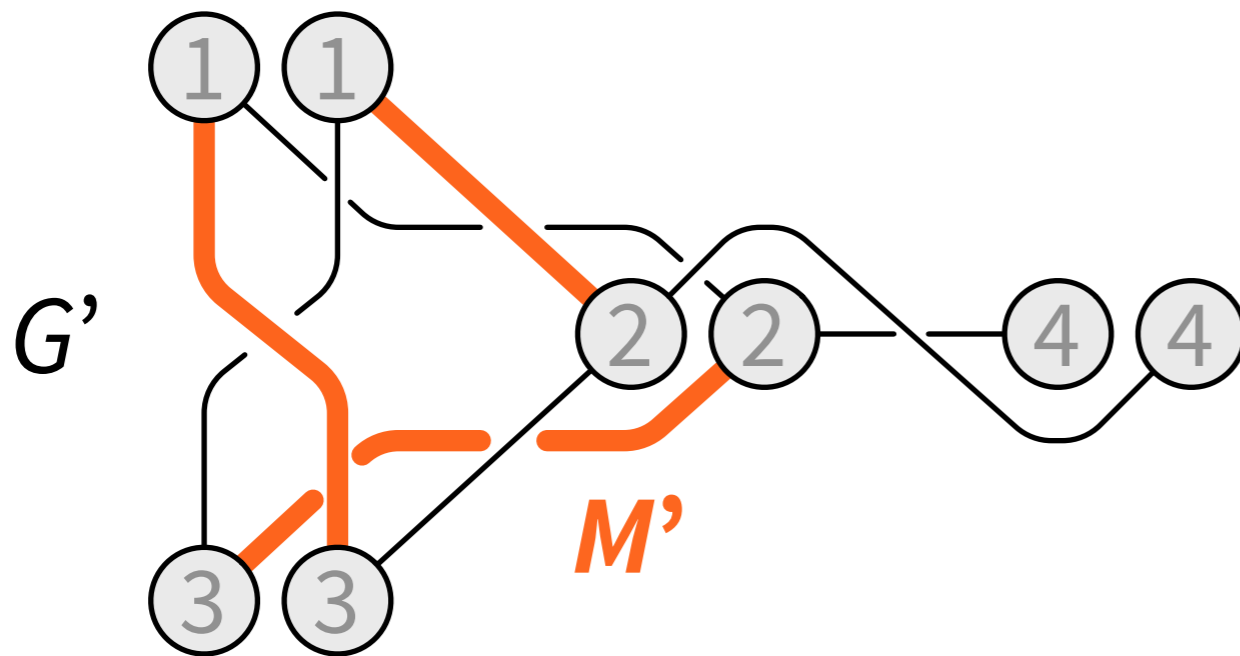

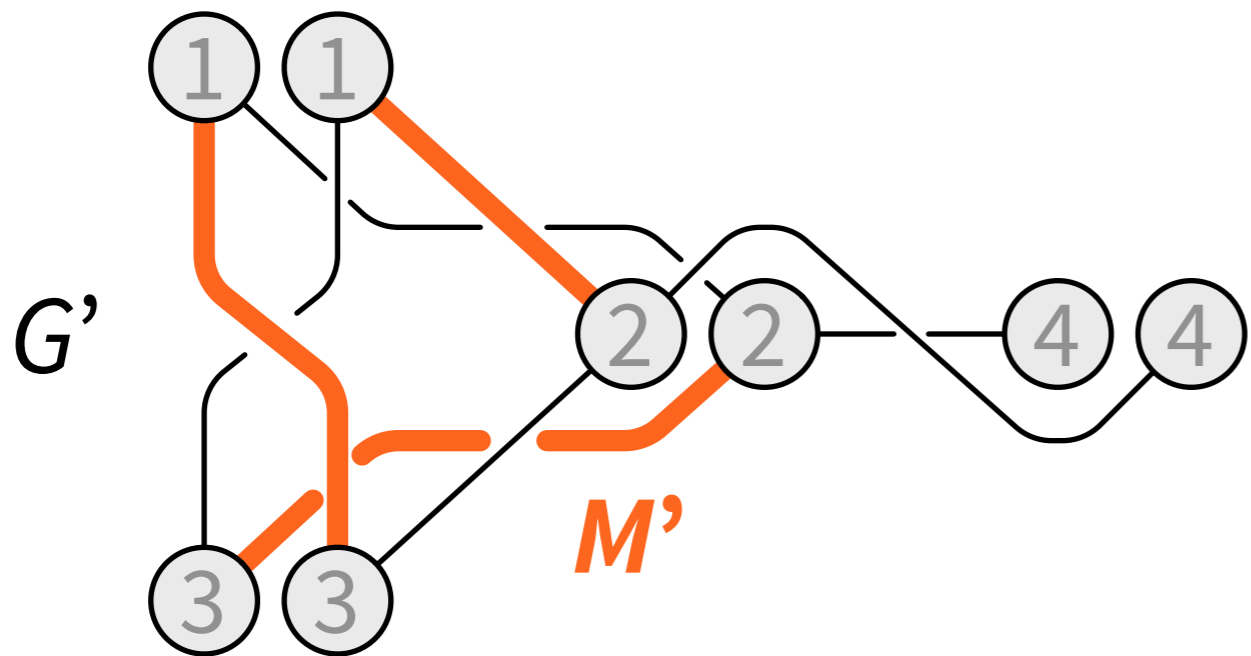
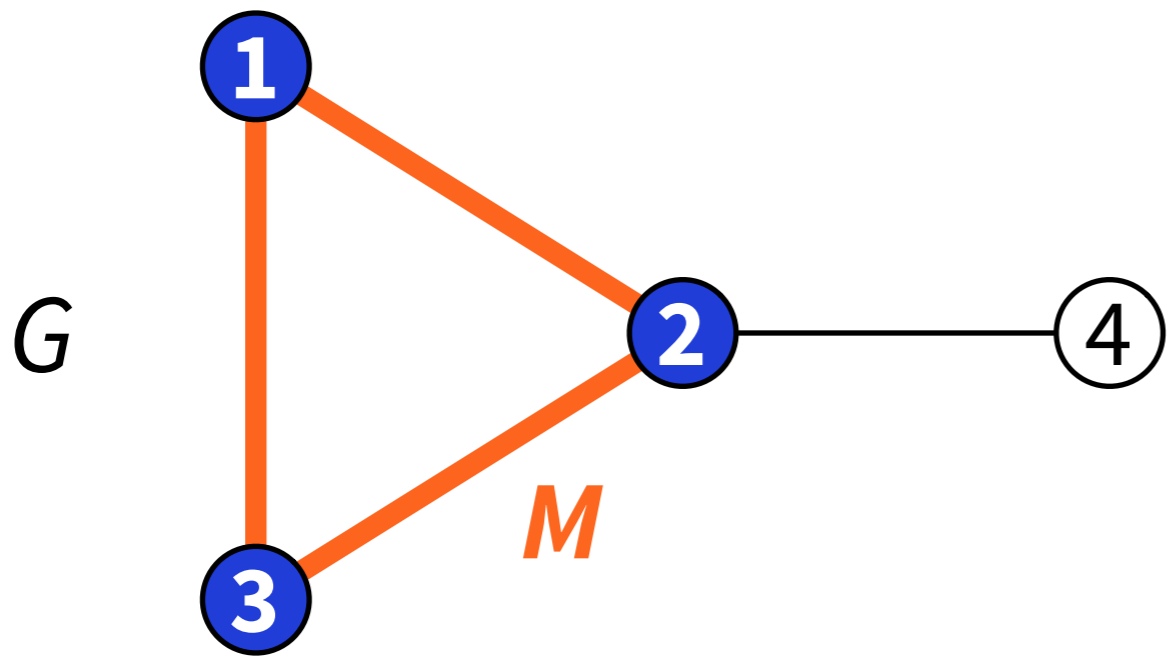

**Virtual node:
incident to
at most 1
edge of M'**

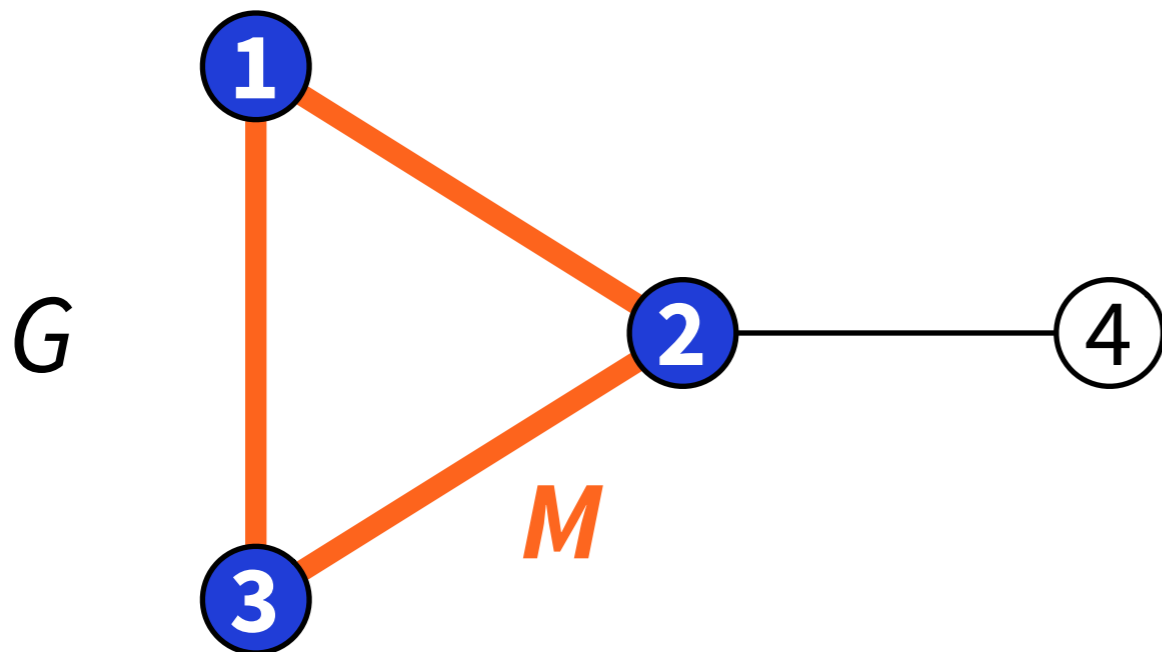

**Original node:
incident to
at most 2
edges of M**

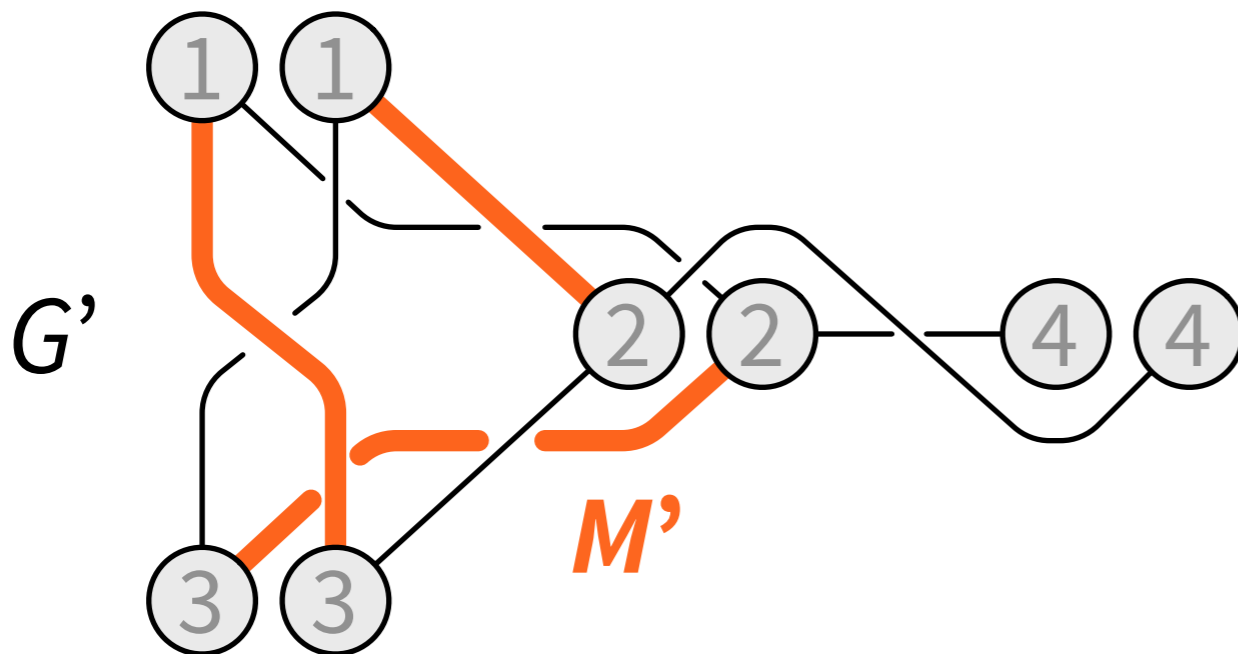

**Virtual node:
incident to
at most 1
edge of M'**

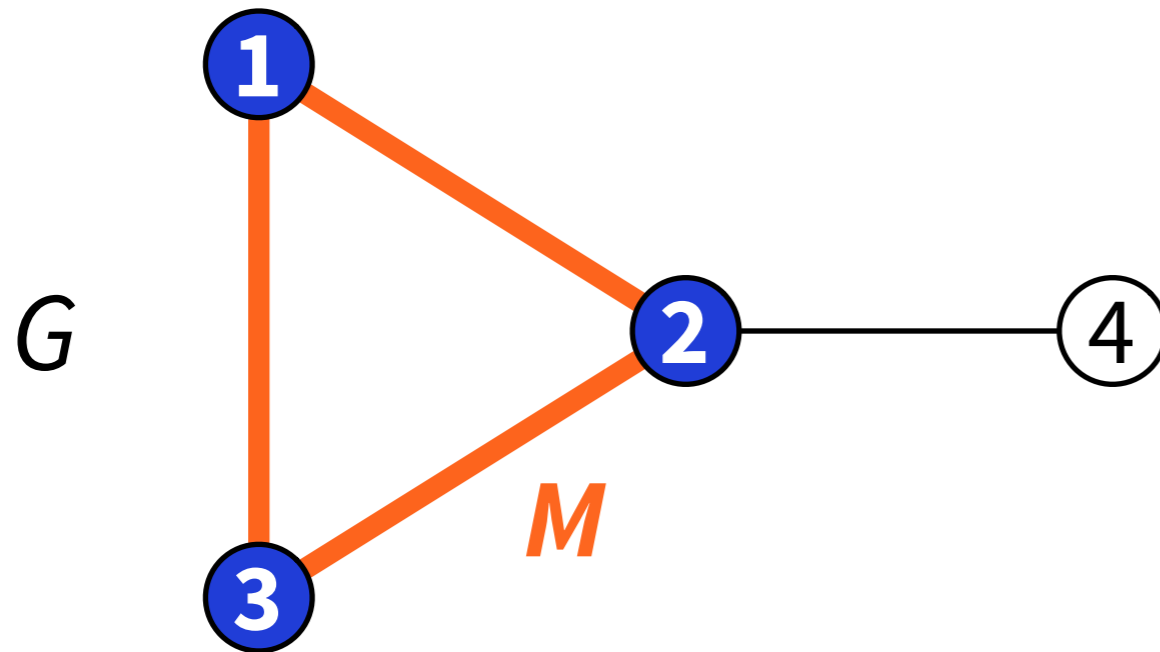

**Original node:
incident to
at most 2
edges of *M***

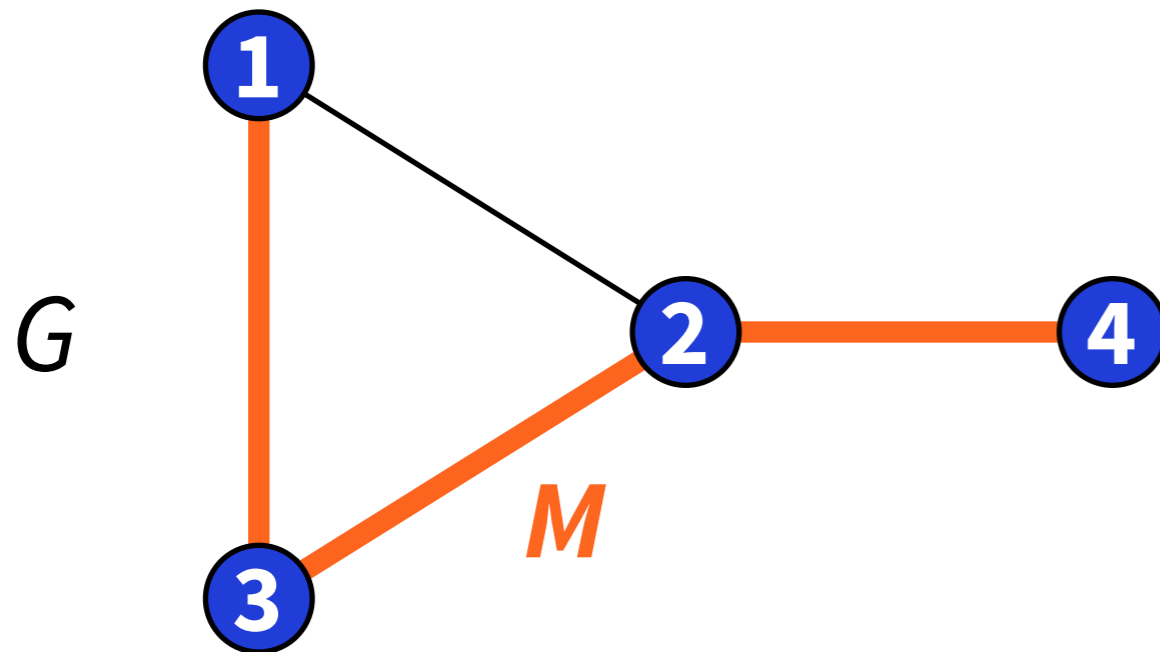

***M* = paths
and/or cycles**

**OPT has to
cover these!**

Algorithm outputs

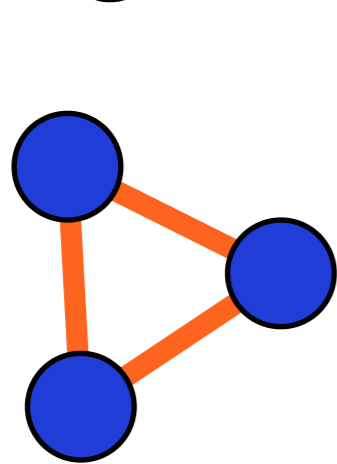

$3/2$

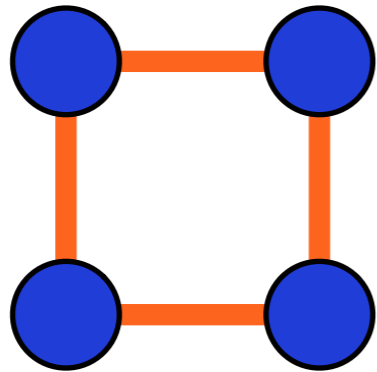

$4/2$

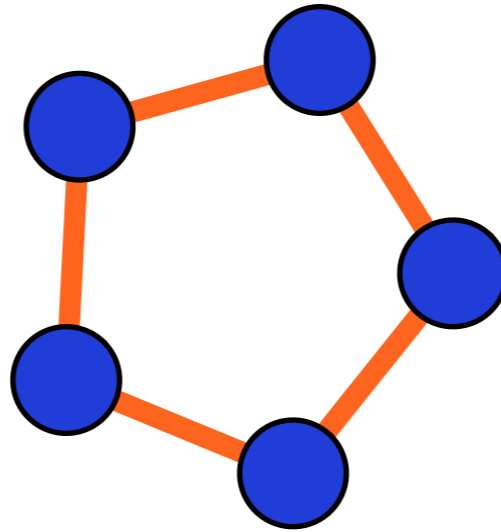

$5/3$



$2/1$

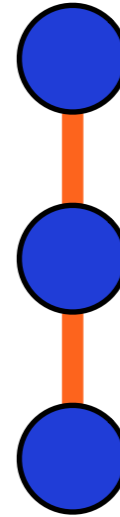

$3/1$

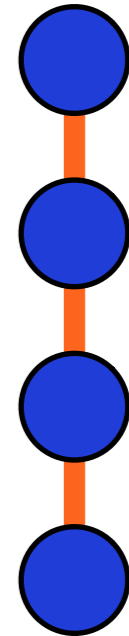

$4/2$

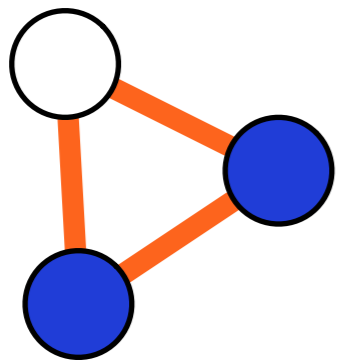

Optimum

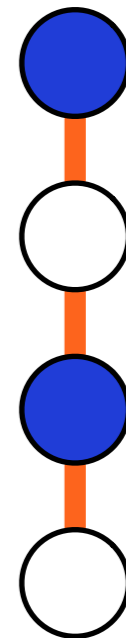
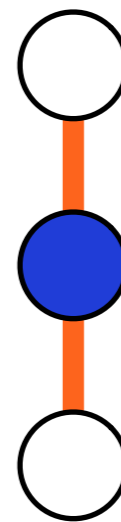
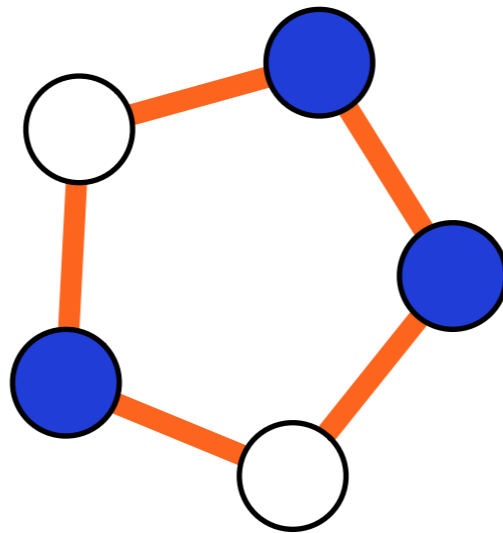
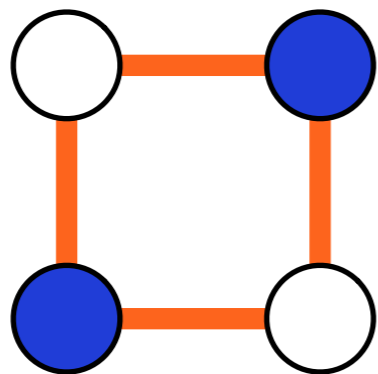

Approximation ratio

Sum over all cycles & paths of M

$\leq 2 \cdot \text{OPT}$ for cycles

$3/2$

$4/2$

$5/3$

$\leq 3 \cdot \text{OPT}$ for paths

$2/1$

$3/1$

$4/2$

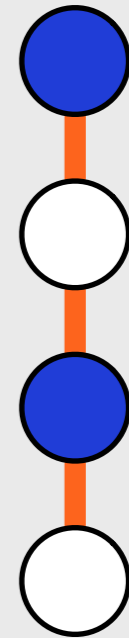
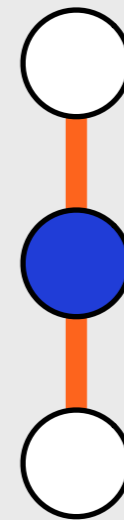
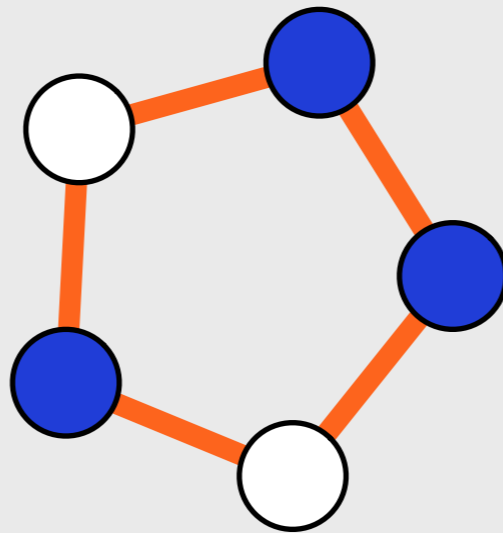
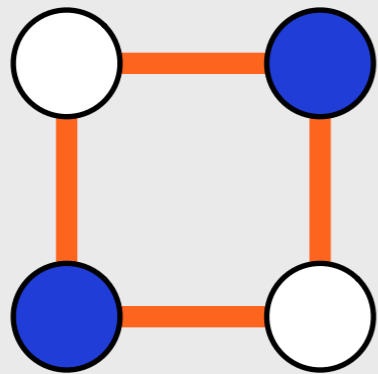
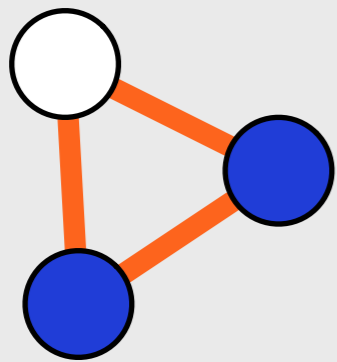

Optimum

Algorithm VC3:

Small vertex covers

- **We can find 3-approximation of a minimum vertex cover in any graph**
- **... assuming that we can find a maximal matching in 2-coloured graphs!**
- **Easy to solve: algorithm BMM**

Algorithm BMM: **Maximal matching**

- **Blue nodes** send proposals to their **orange neighbours one by one**
 - using port numbers
- **Orange nodes** accept **the first proposal that they get**
 - using port numbers to break ties

Algorithm BMM: Maximal matching

- **Input: 2-coloured graph**

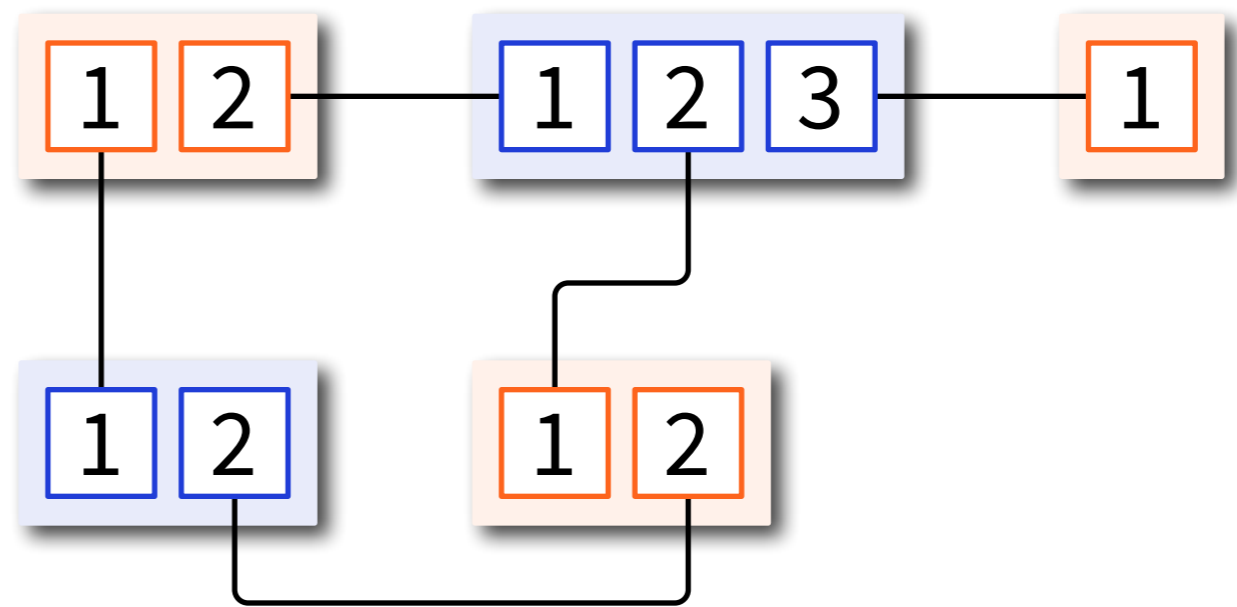
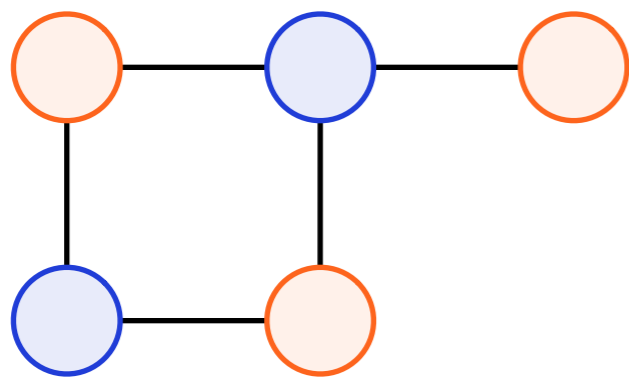

Algorithm BMM: **Maximal matching**

- **Unmatched blue nodes
send proposals to port 1**

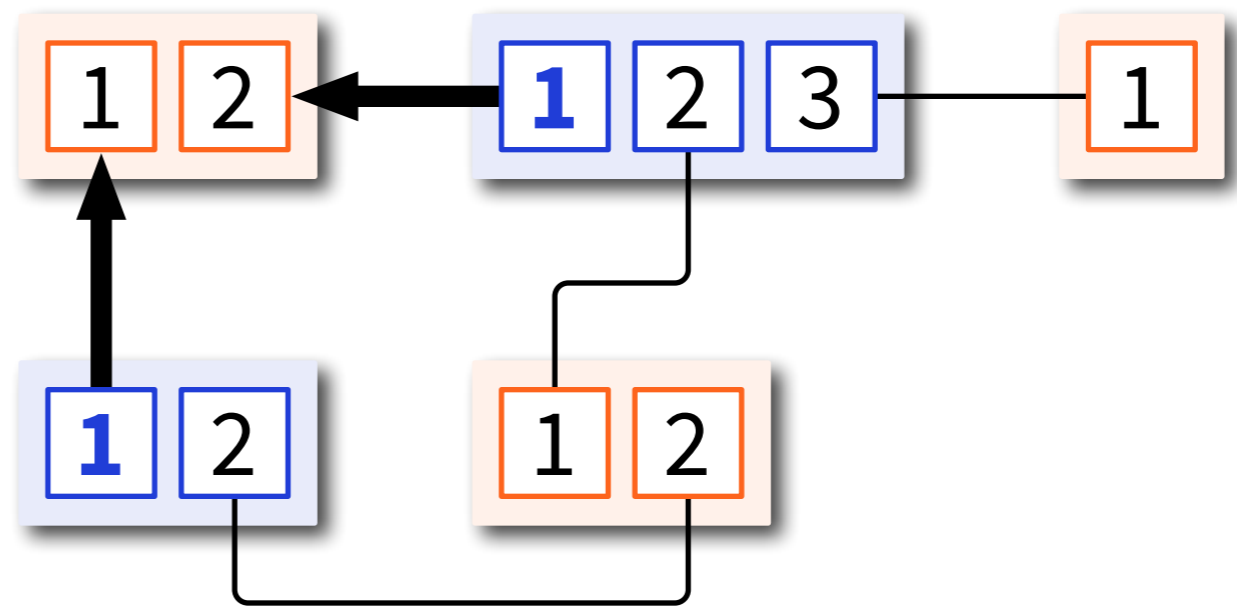
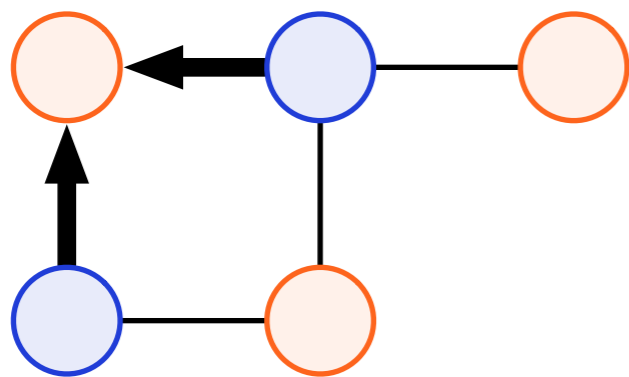

Algorithm BMM: Maximal matching

- **Orange nodes accept the first proposal that they get** (giving priority to small ports)

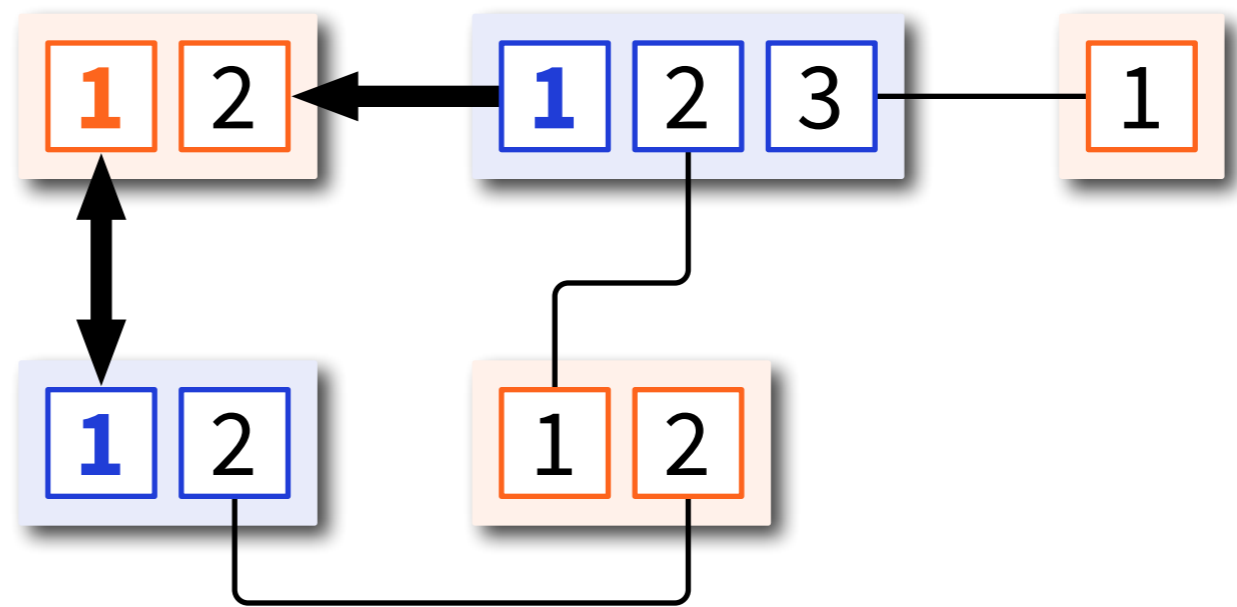
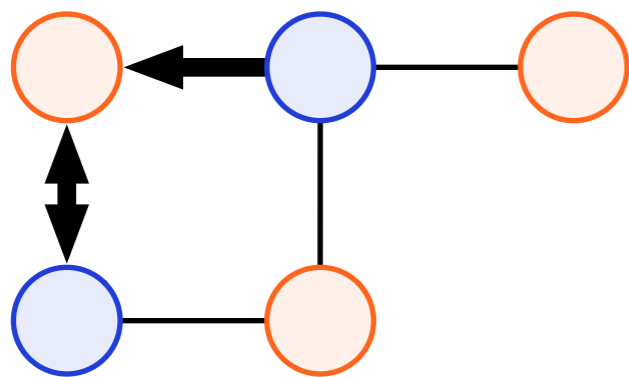

Algorithm BMM: **Maximal matching**

- **Unmatched blue nodes send proposals to port 2**

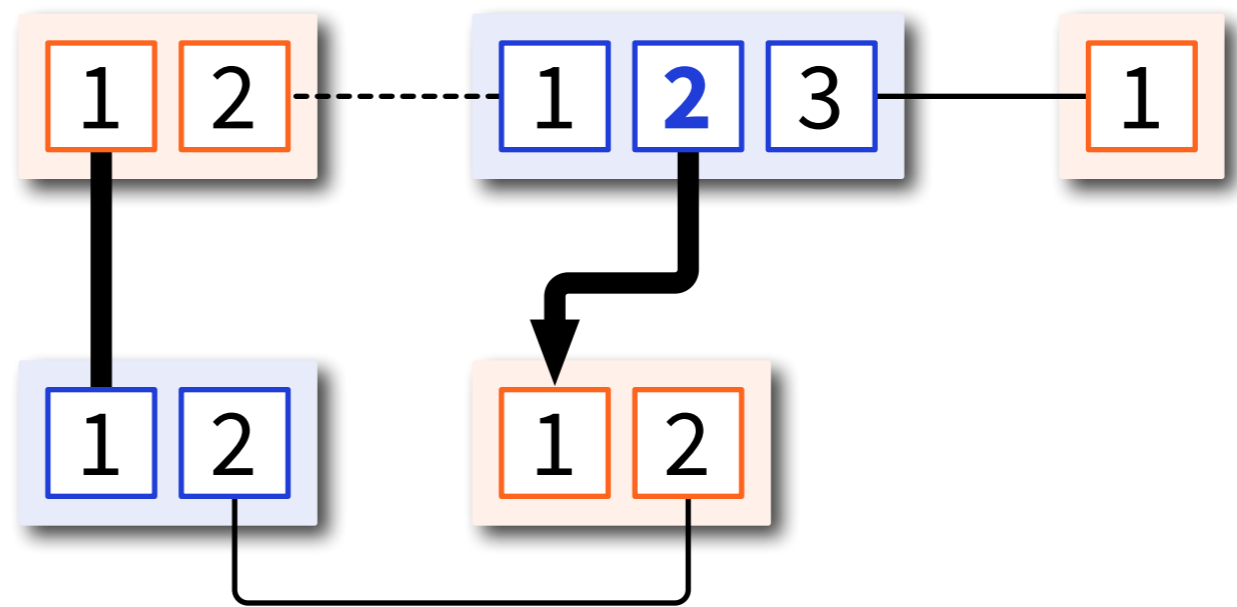
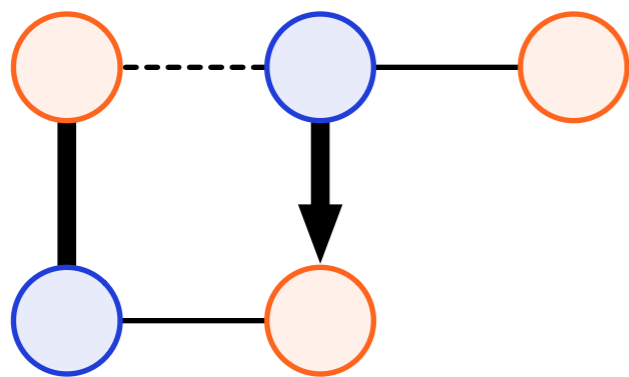

Algorithm BMM: **Maximal matching**

- **Orange nodes accept the first proposal that they get** (giving priority to small ports)

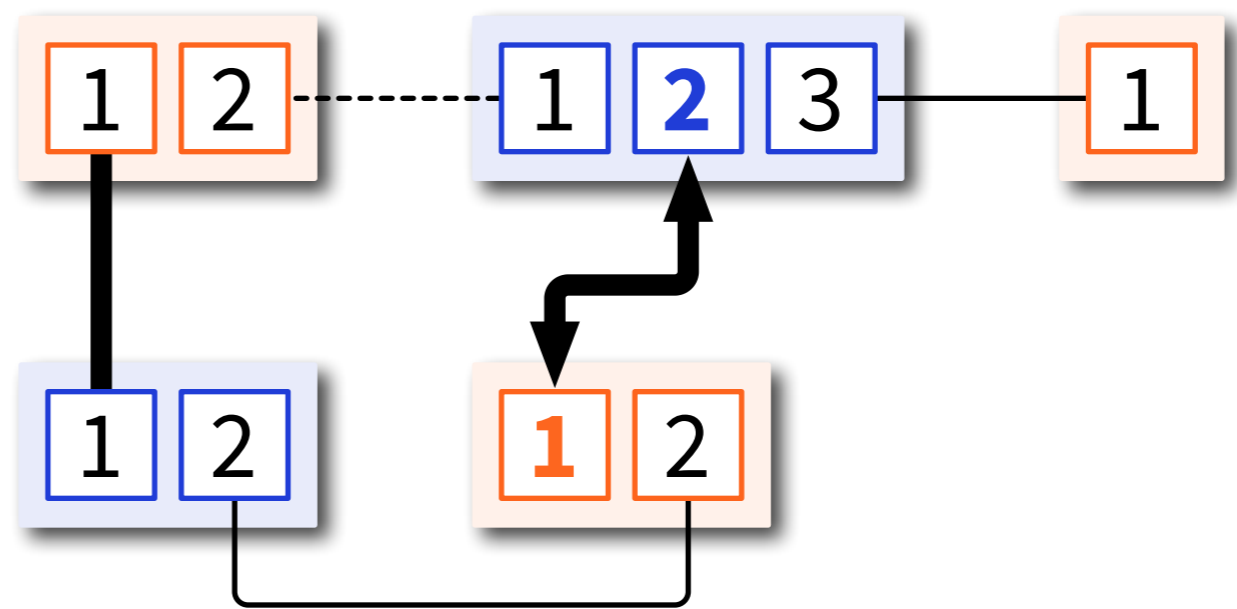
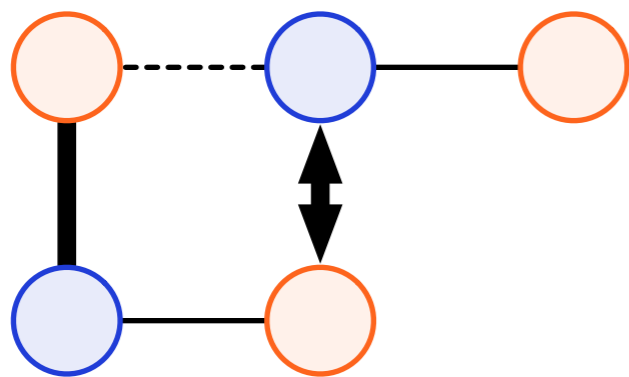

Algorithm BMM: **Maximal matching**

- **Continue until all blue nodes
matched or rejected**

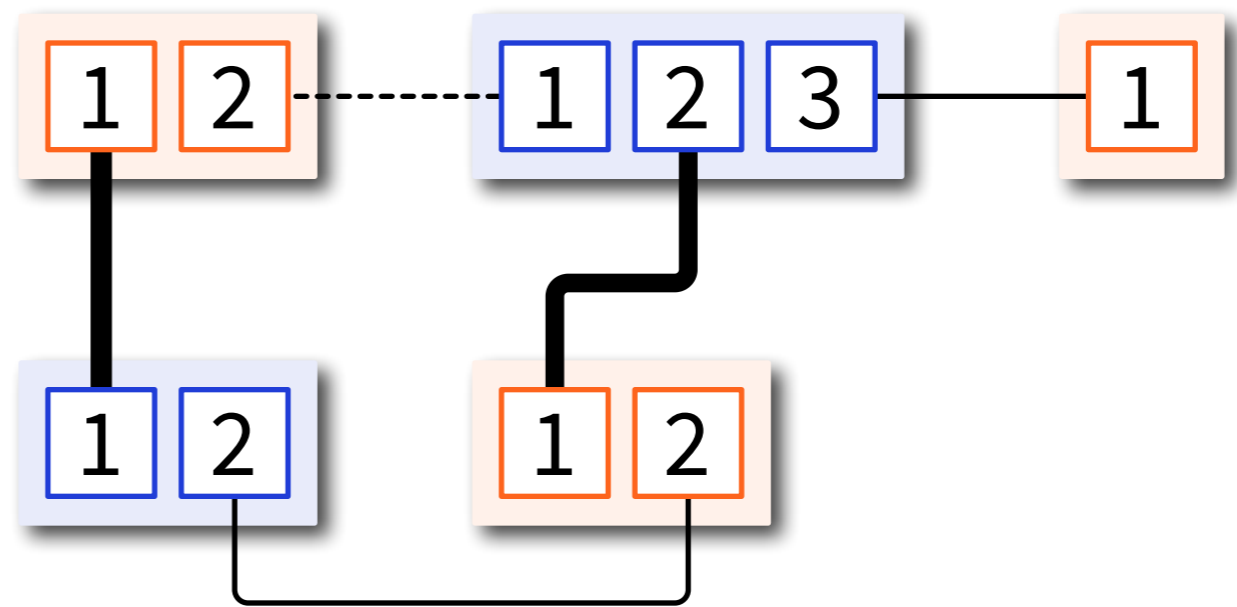
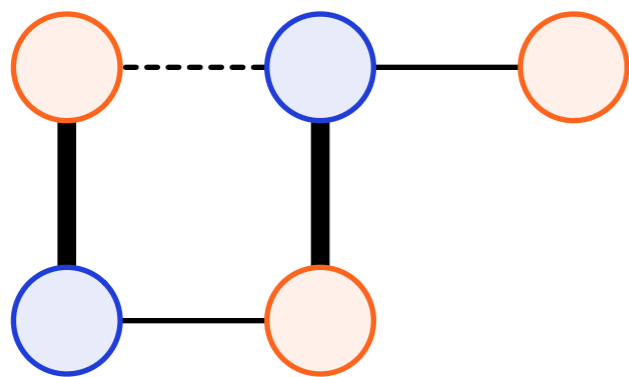

Algorithm BMM: Maximal matching

- All nodes get ≤ 1 partners \rightarrow matching

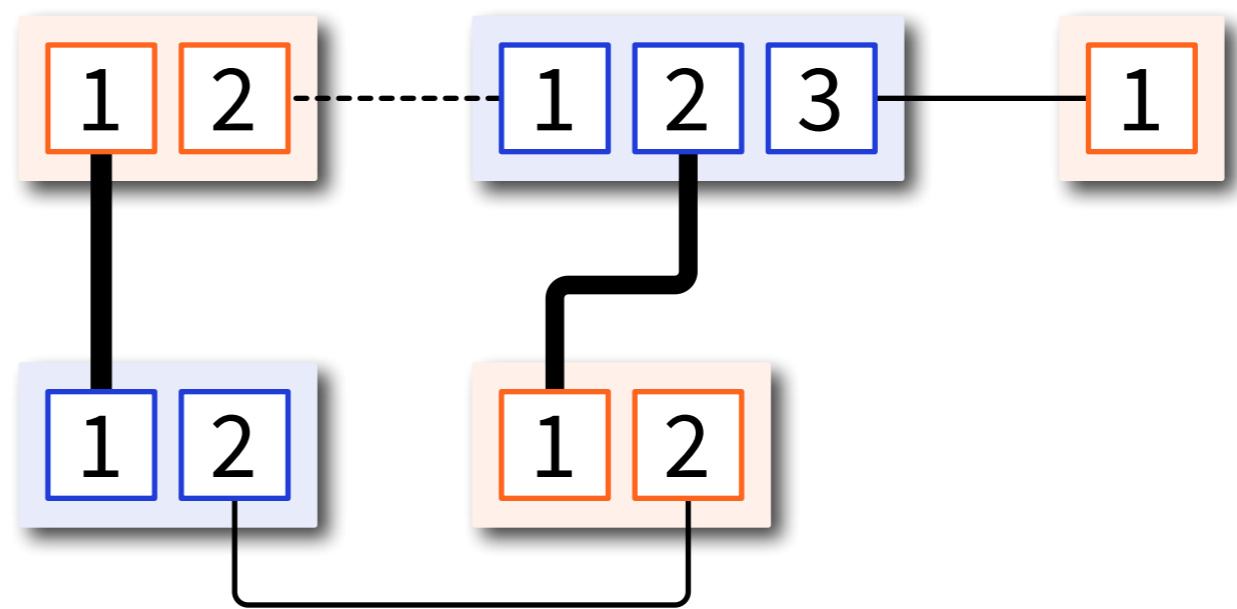
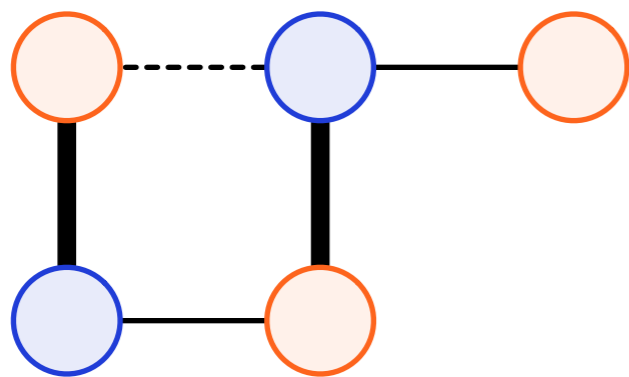

Algorithm BMM: **Maximal matching**

- **Maximality: blue node unmatched only if all orange neighbours reject (= already matched)**

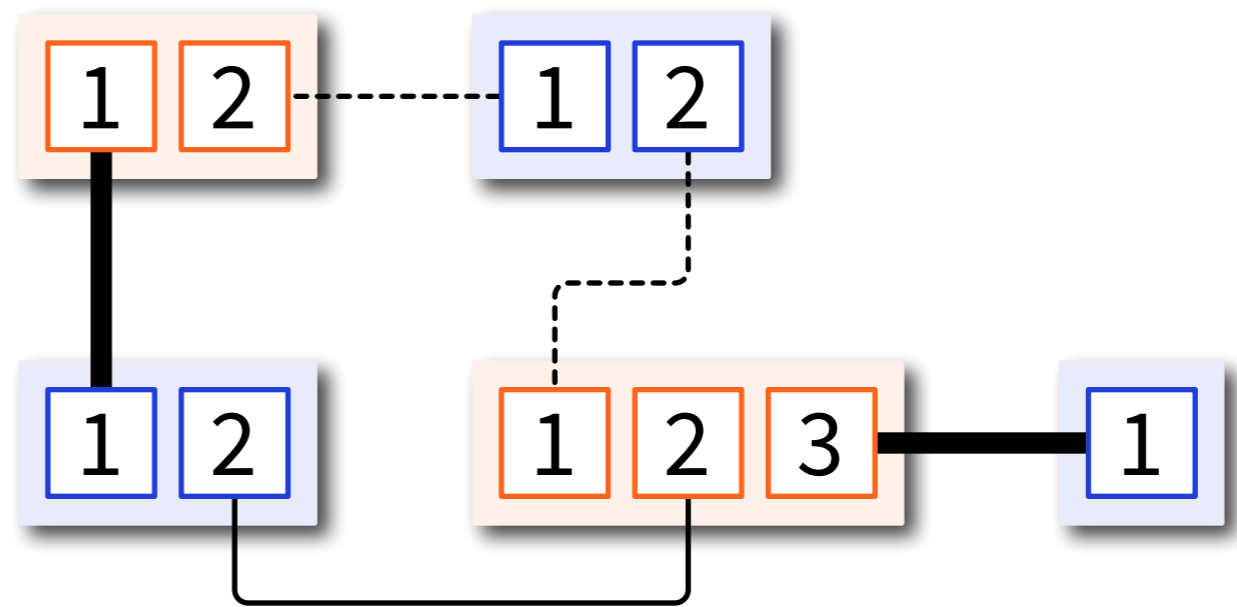
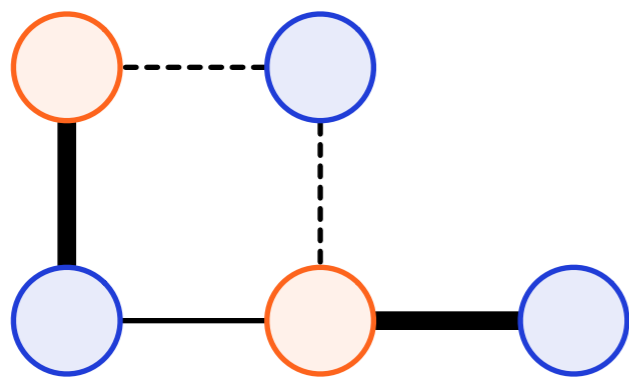

Algorithm BMM: **Maximal matching**

- **Maximality: orange node unmatched only if no proposals** (= blue neighbours are matched)

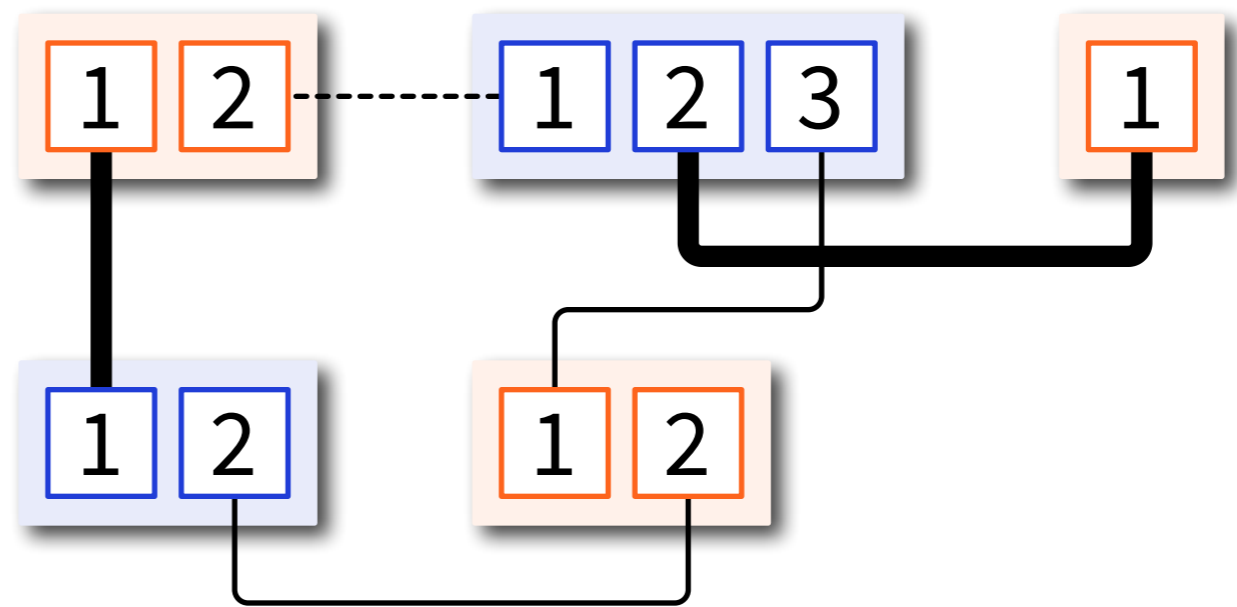
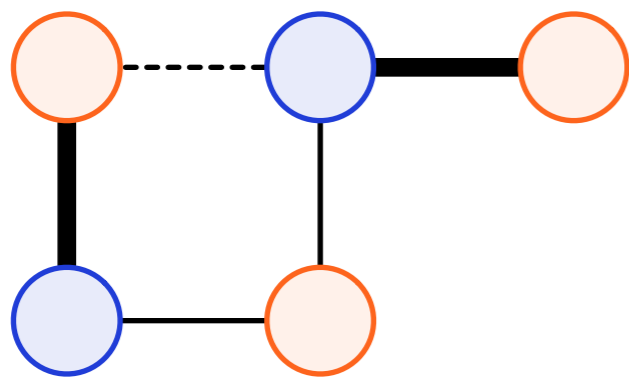

Summary

- **Algorithm BMM:** maximal matching in 2-coloured graphs
- **Algorithm VC3:** 3-approximation of minimum vertex covering in any graph
- **VC3 uses BMM as a subroutine:** virtual 2-coloured graph

Summary

- **There are non-trivial problems that can be solved in the PN model**
 - without unique identifiers, colouring, etc.
- **However, algorithm design much easier if we assume unique IDs**
 - our topic next week

- **Weeks 1–2: informal introduction**

- network = path



- **Week 3: graph theory**

- **Weeks 4–7: models of computing**

- what can be computed (efficiently)?

- **Weeks 8–11: lower bounds**

- what cannot be computed (efficiently)?

- **Week 12: recap**